

brother

KIT I
Installation Guide

ENGLISH

Installationsanleitung
für KIT I

DEUTSCH

Guide d'installation
du KIT I

FRANÇAIS

KIT I
Installatie handleiding

NEDERLANDS

Guida all'installazione
del KIT I

ITALIANO

Guía de instalación
del KIT I

ESPAÑOL

KIT I
Guia de Instalação

PORTUGUÊS

КОМПЛЕКТ I
Руководство по установке

РУССКИЙ

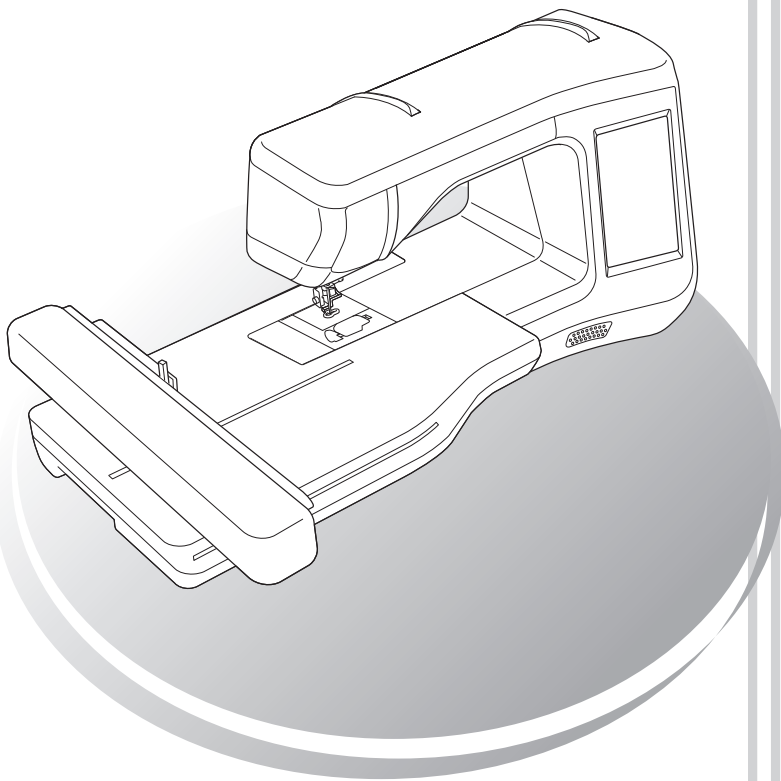

- Read this guide before installing.
- Lesen Sie diese Anleitung vor der Installation durch.
- Lisez ce guide avant de procéder à l'installation.
- Lees deze handleiding alvorens te installeren.
- Leggere la presente guida prima dell'installazione.
- Antes de instalar, lea este guía.
- Leia este guia antes da instalação.
- Перед началом установки прочитайте данное руководство.

Thank you for choosing our product.

For additional product information and updates, visit our website at www.brother.com.

Information found in this guide is current at the time of printing.

Please be aware that some contents of this manual and product specifications are subject to change without notice.

The examples used throughout this guide are screens shots taken from Windows 8.1.

Read this guide before installing.

Vielen Dank, dass Sie sich für unser Produkt entschieden haben.

Weitere Produktinformationen und Aktualisierungen finden Sie auf unserer Website unter www.brother.com. Die Informationen in dieser Anleitung sind zum Zeitpunkt der Drucklegung aktuell.

Beachten Sie bitte, dass Änderungen am Inhalt dieser Bedienungsanleitung und den Produktspezifikationen vorbehalten sind.

Für die Beispiele in dieser Anleitung wurden Bildschirmdarstellungen von Windows 8.1 verwendet.

Lesen Sie diese Anleitung vor der Installation.

Nous vous remercions d'avoir choisi notre produit.

Pour plus d'informations sur les produits et les mises à jour, visitez notre site Web à l'adresse www.brother.com.

Les informations contenues dans de ce guide sont à jour au moment de l'impression.

Le contenu de ce guide et les spécifications de ce produit peuvent être modifiés sans avis préalable.

Les exemples utilisés dans ce guide sont des copies d'écran de Windows 8.1.

Lisez ce guide avant de procéder à l'installation.

Gefeliciteerd met de aanschaf van dit product.

Meer informatie over onze producten en updates vindt u op onze website www.brother.com.

De informatie in deze handleiding was actueel op het moment van afdrukken.

De inhoud van deze handleiding en de specificaties van dit product kunnen zonder kennisgeving worden gewijzigd.

Gebruikte voorbeelden van schermafbeeldingen in deze handleiding zijn gemaakt met Windows 8.1.

Lees deze handleiding voordat u begint met installeren.

Grazie per aver acquistato il nostro prodotto.

Per ulteriori informazioni sui prodotti e sugli aggiornamenti, visitare il nostro sito Web all'indirizzo www.brother.com.

Le informazioni contenute in questa guida sono aggiornate alla data di stampa.

Il contenuto della guida e le specifiche del prodotto sono soggetti a modifiche senza preavviso.

Gli esempi riportati all'interno della presente guida sono screenshot ricavati da Windows 8.1.

Leggere la presente guida prima dell'installazione.

Gracias por elegir nuestro producto.

Si desea obtener actualizaciones o información adicional acerca del producto, visite nuestro sitio web www.brother.com.

La información que se encuentra en esta guía está actualizada al momento de la impresión.

Tenga en cuenta que parte del contenido de este manual y las especificaciones del producto están sujetas a cambios sin previo aviso.

Los ejemplos utilizados en esta guía son capturas de pantalla de Windows 8.1.

Lea esta guía antes de la instalación.

Obrigado por escolher este produto.

Para atualizações e informações adicionais do produto, visite o nosso site na web: www.brother.com.

As informações disponibilizadas neste manual são as atuais no momento da impressão.

Esteja ciente de que alguns conteúdos deste manual e as especificações do produto estão sujeitos a alterações sem aviso prévio.

Os exemplos utilizados neste guia são capturas de tela do Windows 8.1.

Leia este guia antes da instalação.

Благодарим за выбор нашей продукции!

Для получения дополнительной информации и обновлений посетите наш веб-сайт www.brother.com.

Информация, приведенная в настоящем руководстве, действительна на момент печати.

Обратите внимание, что содержимое настоящего руководства и характеристики изделия могут быть изменены без предварительного уведомления.

В качестве примеров в тексте настоящего руководства показаны снимки экранов для операционной системы Windows 8.1.

Перед началом установки прочитайте данное руководство.

CONTENTS

Accessories	2
Using the Manuals	2
Installation Overview	3
Computer Requirements	3
Installation Procedure.....	4

Accessories

The following items are included with your purchase. Please verify all contents and if anything is missing or damaged, contact your authorized dealer.

- **CD-ROM**
The CD-ROM contains the following files.
 - The Certification Key Issuing Wizard
Follow the procedure on this Installation Guide to upgrade your machine.
 - 30 embroidery patterns
 - Embroidery design guide (PDF version)



- **Installation Guide (this guide)**

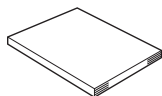

- **Embroidery frame set**
H 30 cm x W 20 cm (H 12 inches x W 8 inches)
After the KIT is activated, this embroidery frame can be used, and the maximum embroidering area becomes wider than on previous frames included with your machine. Several patterns saved on the included CD-ROM can be embroidered using this embroidery frame.

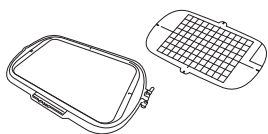

- **Embroidery frame set**
H 20 cm x W 20 cm (H 8 inches x W 8 inches)
This embroidery frame is perfect for quilting.



Using the Manuals

- **Installation Guide (this manual)**
This guide contains descriptions of the accessories, and procedures for upgrading the machine.
- **Operation Manual (PDF version)**
The Operation Manual provides descriptions for using the machine with the added functions and accessories.
Be sure to use the machine and the included accessories according to the descriptions in the Operation Manual.
Adobe Reader is required for viewing and printing the Operation Manual.





Note

- Download a copy of the Operation Manual using the Certification Key Issuing Wizard in step 7 on page 5.

Installation Overview

First, use the Certification Key Issuing Wizard on the enclosed CD-ROM to obtain a Certification Key. Then, use the CERTIFICATION key within the Settings screen, page 4 or 7, to activate the upgrade application for KIT I on the sewing machine.

In the procedures section,  indicates operations performed with the sewing machine and  indicates operations performed with the computer.



[Step 1] Make a note of the internal machine identification number (No.).



[Step 2] Insert the CD-ROM into the computer's CD-ROM drive, and then start the Certification Key Issuing Wizard.



[Step 3] Follow the wizard instructions for obtaining the Certification Key.



[Step 4] Install the upgrade application for KIT I on the sewing machine.



[Step 5] Turn the machine off, remove the USB media device and then turn the machine back on.



[Step 6] After the upgrade has been successfully installed, certify the "KIT I" in the Settings screen of the sewing machine.

Computer Requirements

Before starting the Certification Key Issuing Wizard, check that the computer to be connected meets the following operating conditions.

Computer	IBM-PC or compatible computer
Operating System	Windows Vista, Windows 7, 8, 8.1 (32 or 64bit)
CD-ROM drive	Required for installation
Others	Internet connection available and one available USB port (required to upgrade the sewing machine) when using computer

* "IBM" is a registered trademark of IBM Corporation in the United States and other countries.

* "Windows" and "Windows Vista" are registered trademarks of Microsoft Corporation in the United States and other countries.

* "Adobe" and "Adobe Reader" are either registered trademarks or trademarks of Adobe Systems Incorporated in the United States and/or other countries.

* Each company whose software title is mentioned in this guide has a Software License Agreement specific to its proprietary programs. All other brands and product names mentioned in this guide are registered trademarks of their respective companies. However, the explanations for markings such as ® and ™ are not exhibited clearly within the text.

Installation Procedure

The following procedure describes how to upgrade your sewing machine to KIT I.



Note

- If the procedure described below is not fully completed, your sewing machine cannot be upgraded to KIT I.
- Access to the internet is required in order to download the upgrade program and to obtain a Certification Key.



- 1 Make a note of the 10-digit number (internal machine identification number) displayed beside “No.” on page 4 or 7 of the Settings screen.



Memo

- Make sure the internal machine identification number (No.) is recorded accurately as these numbers need to be entered within the Certification Key Issuing Wizard in order to obtain the Certification Key.



* The number of pages in the Settings screen may differ depending on the version.



Note

- The internal machine identification number that appears beside “No.” is different from the machine serial number (SER. NO.) located on the label attached to the back of the sewing machine.



- 2 Insert the CD-ROM into the computer’s CD-ROM drive.



Memo

- In Windows 7 or Windows Vista, when the **AutoPlay** dialog box appears, click **Open folder to view files**.
- In Windows 8 or 8.1, click on the message **Tap to choose what happens with this disc.** appears on the screen.



- 3 Open the designated drive for your CD-ROM (usually the “D” drive) on **Computer (My Computer)**, double-click  to start the **Certification Key Issuing Wizard**.



Memo

- The following procedure can be used to start the Certification Key Issuing Wizard.
 1. Click **Start**.
 2. Click **Run** or in the search box, type run, and then, in the list of results, click **Run**.

→ The **Run** dialog box appears.

3. Type the path to the application file (**D:\KeyWizard_KIT1.exe**), and then click **OK**.

→ The **Select Language** dialog box automatically appears.



- 4 Select the desired language, and then click “OK”.



→ **KIT I Certification Key Issuing Wizard** appears.



- 5 Carefully read the information that appears, and then click “Next”.

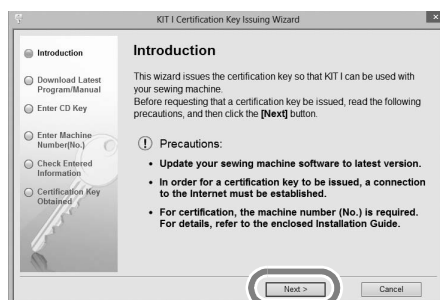



- 6** Download the latest upgrade program.
Confirm the model of your machine, click **“Download”**, then save the upgrade program (*****.upf) to your computer. Click **“Next”**.

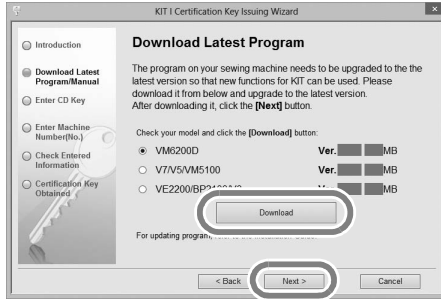

Click **“OK”** to close the message below.

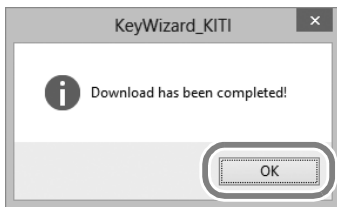

Note

- If the displayed version or later has already been installed in the machine (see step **1** on page 4), click **“Next”** to continue with the procedure without downloading the latest file. Follow step **8** to **12**, and skip step **13** to **18**, then start the procedure from step **19** on page 9.



- 7** Download the manual.
Select your preferred language and click **“Download”** to save the file to your computer, then click **“Next”**.

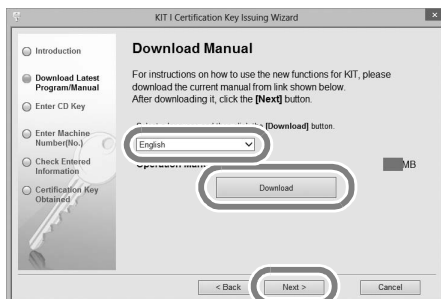

- 8** Type in the 15-digit CD key found on the label attached to the CD-ROM envelope of the upgrade kit, and then click **“Next”**

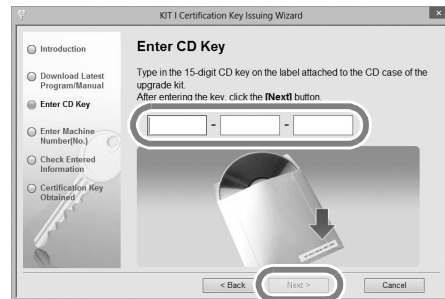

Note

- Type in the CD key on the label attached to the CD-ROM envelope for machines.

If an error message appears

Check below list for possible entry error(s). To close the message, click **“OK”**.

- Are symbols or characters other than letters and numbers entered?
- Has the uppercase letter “l” been entered in place of the number “1”?
- Has the uppercase letter “O” been entered in place of the number “0”?



Memo

- The uppercase letter “O” and “l” are not used in the CD Key. Also, no symbols are used in the CD key.



- 9 Type in the internal machine identification number (No.) written down in step 1, and then click **“Next”**.

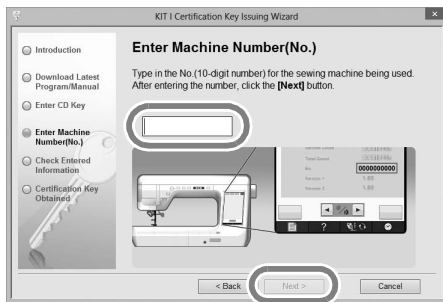

If an error message appears

Check that symbols or characters other than numbers have not been entered. To close the message, click **“OK”**.



- 10 Carefully verify that the information has been entered correctly and then click **“Certify”**.

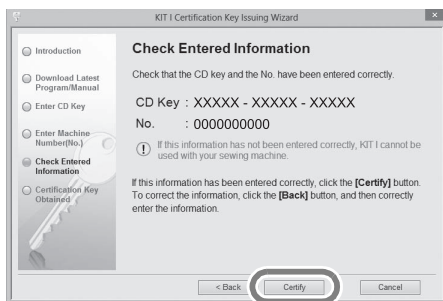

Memo

- To change the entered information, click **“Back”**.

If an error message appears

Check below list for possible error(s). To close the message, click **“OK”**.

- Verify that the CD key and internal machine identification number (No.) have been entered correctly, and then repeat the procedure from step 3.
- The CD Key is valid for use with only one designated internal machine identification number (No.). Check that the CD key has been entered correctly, and then repeat the procedure from step 3.
- Check the Internet connection, and then click **“Certify”** again.



- 11 Write down the 8-digit Certification Key that appears.



Note

- After upgrading the sewing machine to KIT I, the Certification Key must be entered in the sewing machine Settings screen.



- 12 Click **“Finish”**.

The certification key has been successfully obtained.

Now proceed to installing the upgrade application for KIT I on the sewing machine.

Use USB media or a computer to install the upgrade application.

If **USB media** is to be used, refer to the instructions that follow.

If a **computer** is to be used, refer to the procedure described on page 8.

When using USB media to perform the installation



- 13 While pressing the “Automatic Threading” button, turn the sewing machine on.



- 14 Copy the upgrade program downloaded in step 6 to the USB media.



Note

- Copy only the upgrade program to a clean re-formatted USB media; no other files should be on this media.



- 15 Press .

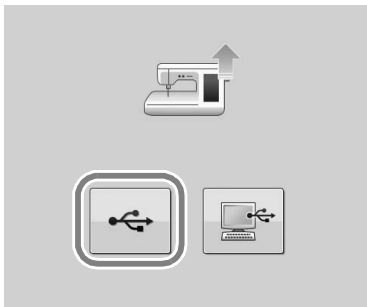

- 16 Insert the USB media into the primary (top) USB port connector on the right side of the machine. It will take a few seconds until the machine recognizes that the USB media has been inserted into the port.



- 17 Press .

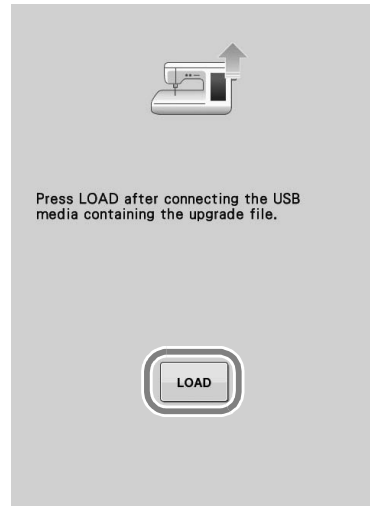

Note

- When the message “**Upgrade complete.**” appears, installation of the upgrade application has been completed.
(If an error occurs, a message will appear in red.)



- 18 Remove the USB media.

Continue with step 19 on page 9.

When using a computer to perform the installation



- 13 While pressing the “Automatic Threading” button, turn the sewing machine on.



- 14 Press .

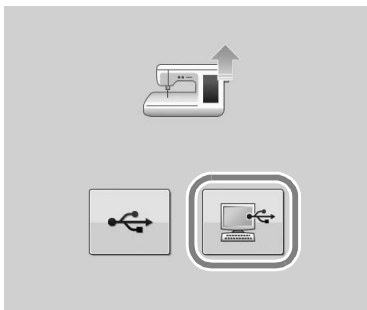

- 15 Plug the USB cable connectors into the corresponding USB port connectors for the computer and for the machine.

→ **Removable Disk** appears in **Computer (My Computer)**.



Note

- Do not connect any additional USB media devices to your computer when using the USB cable.



- 16 Copy the upgrade program downloaded in step 6 to the **Removable Disk**.

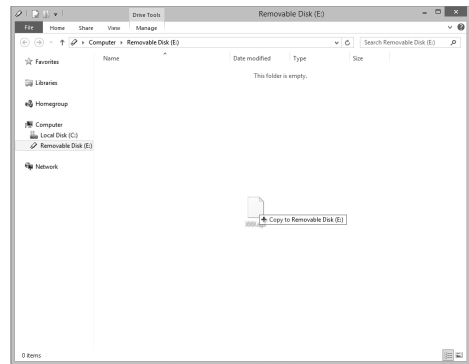

Note

- The “**Connected to PC. Do not disconnect the USB cable**”. message appears on the sewing machine LCD screen.



- 17 Press .



Note

- When the message “**Upgrade complete.**” appears, installation of the upgrade application has been completed.
(If an error occurs, a message will appear in red.)



18 Unplug the USB cable.



19 Turn the sewing machine off, then on again.

20 Display page 4 or 7 of the Settings screen.



21 Press **CERTIFICATION** in the Settings screen.



22 Press **KIT 1** in the following screen.



23 Type in the 8-digit Certification Key written down in step 11, and then press **SET**.

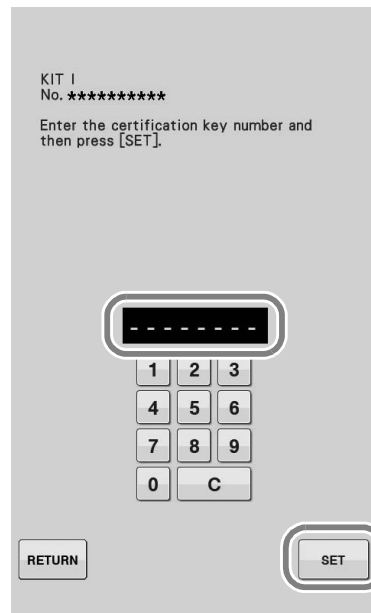



- 24 Certification has been completed when the following screen appears. Turn off the sewing machine and then turn on again.

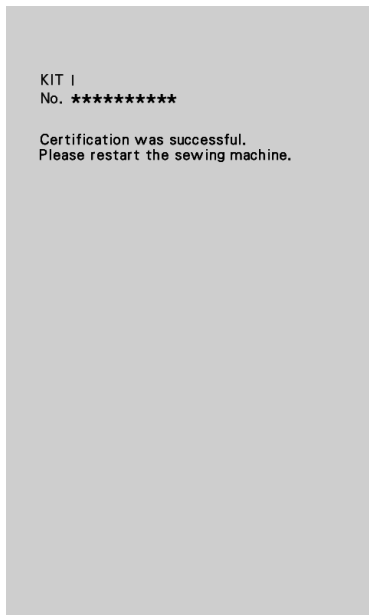

- 25 Confirm that there is a check mark beside "KIT I" in the Settings screen.
- The "KIT I" has been successfully certified.



Note

- If the following screen appears, type in the 8-digit Certification Key written down in step 11, and then press **SET**.

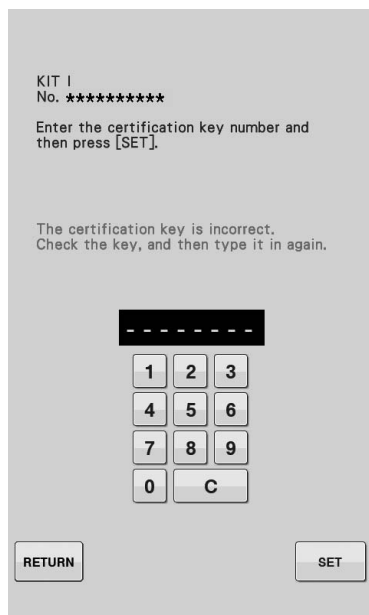

- If the Certification Key is lost, repeat steps 2 through 12 to attain the Certification Key.



Note

- For details of the upgraded functions, see the Operation Manual (PDF version) downloaded using the Certification Key Issuing Wizard. Please refer to page 5 for Operation Manual download information.

INHALT

Zubehör	2
Verwendung der Anleitungen	2
Installationsübersicht	3
Computer-Systemvoraussetzungen	3
Installation	4

Zubehör

Die folgenden Teile gehören zum Lieferumfang. Prüfen Sie die Lieferung auf Vollständigkeit und wenden Sie sich an Ihren Vertragshändler, wenn etwas fehlen oder beschädigt sein sollte.

- **CD-ROM**
Die CD-ROM enthält die folgenden Dateien.
 - Assistent zur Erzeugung eines Bestätigungsschlüssels
Folgen Sie zur Aktualisierung der Maschine der Prozedur in dieser Installationsanleitung.
 - 30 Stickdesigns
 - Stickmuster-Katalog (PDF-Version)



- **Installationsanleitung (diese Anleitung)**

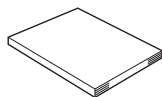

- **Stickrahmenset**
H 30 cm × B 20 cm (H 12 Zoll × B 8 Zoll)
Nach der KIT-Aktivierung kann dieses Stickrahmenset verwendet werden und der maximale Stickbereich wird größer als mit den im Lieferumfang der Maschine enthaltenen Stickrahmen. Mit diesem Stickrahmen können mehrere auf der CD-ROM enthaltene Stickmuster gestickt werden.

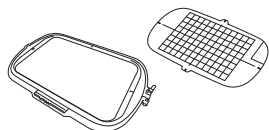

- **Stickrahmenset**
H 20 cm × B 20 cm (H 8 Zoll × B 8 Zoll)
Dieser Stickrahmen eignet sich perfekt zum Quilten.



Verwendung der Anleitungen

- **Installationsanleitung (diese Anleitung)**
Diese Anleitung beschreibt das Zubehör und die Verfahren zur Aktualisierung der Maschine.
- **Bedienungsanleitung (PDF-Version)**
Die Bedienungsanleitung beinhaltet Beschreibungen zur Verwendung der Maschine, einschließlich den zusätzlichen Funktionen und des Zubehörs.
Verwenden Sie die Maschine und das mitgelieferte Zubehör ausschließlich entsprechend den Beschreibungen in der Bedienungsanleitung.
Für die Anzeige und zum Ausdrucken der Bedienungsanleitung ist der Adobe Reader erforderlich.



Hinweis

- Laden Sie mit dem Assistenten zur Erzeugung eines Bestätigungsschlüssels eine Kopie der Bedienungsanleitung herunter (siehe Schritt 7 auf Seite 5).

Installationsübersicht

Verwenden Sie zuerst den Assistenten zur Erzeugung eines Bestätigungsschlüssels auf der mitgelieferten CD-ROM, um den Bestätigungsschlüssel zu erhalten. Verwenden Sie dann im Einstellungsbildschirm, Seite 4 oder 7, den ZERTIFIZIERUNG um das Aktualisierungsprogramm für KIT I in der Nähmaschine zu aktivieren.

In der Anleitung weist  auf Handlungen an der Nähmaschine und  auf Handlungen am Computer hin.



[Schritt 1] Notieren Sie die interne Maschinenummer (No.).



[Schritt 2] Legen Sie die CD-ROM in das CD-ROM-Laufwerk des Computers ein und starten Sie den Assistenten zur Erzeugung eines Bestätigungsschlüssels.



[Schritt 3] Folgen Sie den Hinweisen des Assistenten, um den Bestätigungsschlüssel zu erhalten.



[Schritt 4] Installieren Sie das Aktualisierungsprogramm für KIT I auf der Nähmaschine.



[Schritt 5] Schalten Sie die Maschine aus, entfernen Sie das USB-Medium und schalten Sie die Maschine wieder ein.



[Schritt 6] Wenn die Aktualisierung erfolgreich installiert ist, bestätigen Sie das „KIT I“ im Einstellungsbildschirm der Nähmaschine.

Computer-Systemvoraussetzungen

Bevor Sie den Assistenten zur Erzeugung eines Bestätigungsschlüssels starten, prüfen Sie, dass der anzuschließende Computer die folgenden Systemvoraussetzungen erfüllt.

Computer	IBM-PC oder ein kompatibler Computer
Betriebssystem	Windows Vista, Windows 7, 8, 8.1 (32 oder 64 Bit)
CD-ROM-Laufwerk	Für die Installation erforderlich
Sonstige	Eine verfügbare Internetverbindung und ein freier USB-Port sind für das Upgrade der Nähmaschine erforderlich.

* „IBM“ ist ein eingetragenes Warenzeichen der IBM Corporation in den USA und anderen Ländern.

* „Windows“ und „Windows Vista“ sind eingetragene Warenzeichen der Microsoft Corporation in den USA und in anderen Ländern.

* „Adobe“ und „Adobe Reader“ sind eingetragene Warenzeichen oder Warenzeichen der Adobe Systems Incorporated in den USA und/oder anderen Ländern.

* Jedes Unternehmen, dessen Software in dieser Anleitung erwähnt wird, hat eine seinen eigenen Programmen entsprechende Softwarelizenzvereinbarung. Alle anderen in dieser Anleitung erwähnten Marken- und Produktnamen sind Warenzeichen der jeweiligen Unternehmen. Kennzeichen, wie z. B. ® und ™, werden im Text jedoch nicht extra hervorgehoben.

Installation

Nachfolgend wird die Aktualisierung der Nähmaschine auf KIT I beschrieben.



Hinweis

- Wenn Sie den unten beschriebenen Vorgang nicht abschließen, kann die Nähmaschine nicht mit dem KIT I aktualisiert werden.
- Damit Sie das Aktualisierungsprogramm herunterladen und den Bestätigungsschlüssel erhalten können, ist ein Internetzugang erforderlich.



- 1 Notieren Sie sich die 10-stellige Nummer (interne Maschinenummer), die neben „No.“ auf Seite 4 oder 7 des Einstellungsbildschirms angezeigt wird.



Anmerkung

- Achten Sie darauf, dass Sie die interne Maschinenummer (No.) fehlerfrei notieren, da diese Nummer im Assistenten zur Erzeugung eines Bestätigungsschlüssels eingegeben werden muss, um einen Bestätigungsschlüssel zu erhalten.

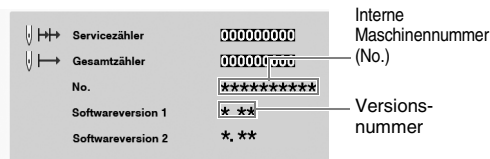

* Die Seitenzahl im Einstellungsbildschirm kann je nach Version variieren.



Hinweis

- Die interne Maschinenummer neben „No.“ unterscheidet sich von der Seriennummer (SER. NO.) auf dem Typenschild auf der Rückseite der Nähmaschine.



- 2 Legen Sie die CD-ROM in das CD-ROM-Laufwerk des Computers ein.



Anmerkung

- Wenn in Windows 7 oder Windows Vista das Dialogfeld **AutoPlay** angezeigt wird, klicken Sie auf **Ordner zur Anzeige der Dateien öffnen**.
- Klicken Sie unter Windows 8 oder 8.1 auf die Meldung **Tippen Sie hier, um eine Aktion für diese Disc auszuwählen.**, wenn sie am Bildschirm angezeigt wird.



- 3 Öffnen Sie das der CD-ROM zugewiesene Laufwerk (in der Regel Laufwerk „D“) unter **Computer (Arbeitsplatz)** und doppelklicken Sie auf , um den **Assistenten zur Erzeugung eines Bestätigungsschlüssels** zu starten.



Anmerkung

- Der Assistent zur Erzeugung eines Bestätigungsschlüssels kann wie folgt geöffnet werden.
 1. Klicken Sie auf **Starten (Start)**.
 2. Klicken Sie auf **Ausführen** oder geben Sie „Ausführen“ im Suchfeld ein und klicken Sie in der Ergebnisliste auf „Ausführen“.→ Das Dialogfeld **Ausführen** wird angezeigt.
 3. Geben Sie den Pfad (**D:\KeyWizard_KITI.exe**) der Programmdatei ein und klicken Sie auf **OK**.

→ Das Dialogfenster **Select Language (Sprache auswählen)** wird automatisch angezeigt.



- 4 Wählen Sie die gewünschte Sprache aus und klicken Sie auf „OK“.



→ **KIT I Assistent zur Erzeugung eines Bestätigungsschlüssels** wird angezeigt.



- 5 Lesen Sie die angezeigten Informationen aufmerksam und klicken Sie dann auf „Weiter“.

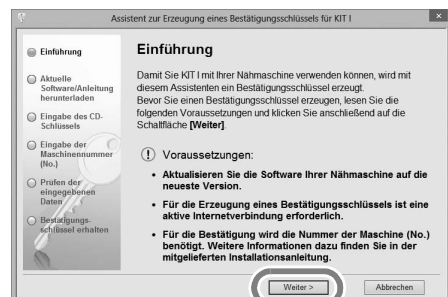



- 6** Laden Sie die aktuelle Version des Aktualisierungsprogramms herunter. Bestätigen Sie Ihr Maschinenmodell, klicken Sie auf **„Herunterladen“** und speichern Sie das Aktualisierungsprogramm (*****.upf) auf dem Computer. Klicken Sie auf **„Weiter“**.

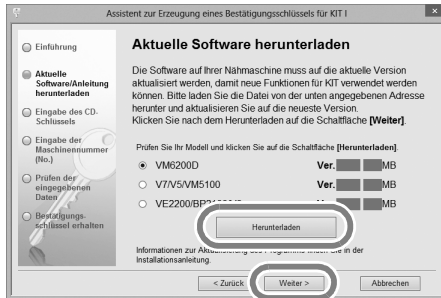

Klicken Sie auf **„OK“**, um die Meldung unten zu schließen.



Hinweis

- Wenn die angezeigte oder eine neuere Version bereits auf der Maschine installiert ist (siehe Schritt **1** auf Seite 4), klicken Sie auf **„Weiter“**, um mit der Installation ohne Herunterladen der neuesten Datei fortzufahren. Führen Sie die Schritte **8** bis **12** aus, überspringen Sie die Schritte **13** bis **18** und beginnen Sie den Vorgang ab Schritt **19** auf Seite 9.



- 7** Laden Sie das Handbuch herunter. Wählen Sie die gewünschte Sprache aus und klicken Sie dann auf **„Herunterladen“**, um die Datei auf dem Computer zu speichern, und klicken Sie anschließend auf **„Weiter“**.

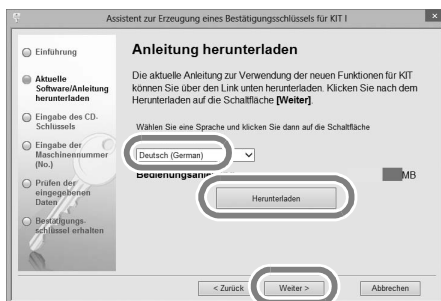

- 8** Geben Sie den auf dem Etikett der CD-ROM-Hülle des Upgrade-Kits gedruckten 15-stelligen CD-Schlüssel ein und klicken Sie auf **„Weiter“**.



Hinweis

- Geben Sie den CD-Schlüssel auf dem Hüllenetikett der CD-ROM für Maschinen ein.

Wenn eine Fehlermeldung angezeigt wird Prüfen Sie die folgende Liste auf mögliche Eingabefehler. Zum Schließen der Meldung, klicken Sie auf **„OK“**.

- Wurden Symbole oder Zeichen eingegeben, die keine Buchstaben und Zahlen sind?
- Wurde anstelle der Zahl „1“ der Großbuchstabe „I“ eingegeben?
- Wurde anstelle der Zahl „0“ der Großbuchstabe „O“ eingegeben?



Anmerkung

- Die Großbuchstaben „O“ und „I“ werden im CD-Schlüssel nicht verwendet. Im CD-Schlüssel werden außerdem keine Symbole verwendet.



- 9** Geben Sie die interne Maschinenummer (No.) ein, die Sie in Schritt **1** notiert haben und klicken Sie auf „Weiter“.

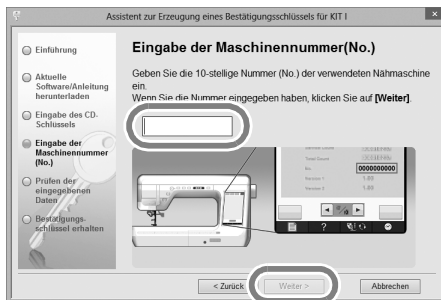

Wenn eine Fehlermeldung angezeigt wird

Stellen Sie sicher, dass Sie nur Ziffern und Buchstaben eingegeben haben. Zum Schließen der Meldung, klicken Sie auf „OK“.



- 10** Prüfen Sie sorgfältig, dass die Informationen richtig eingegeben worden sind, und klicken Sie dann auf „Bestätigen“.

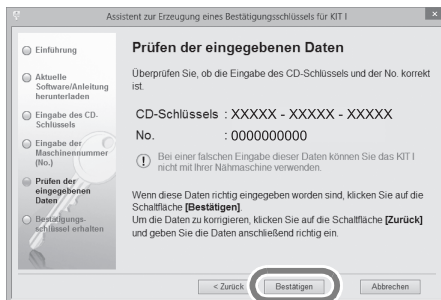

Anmerkung

- Um die eingegebenen Informationen zu ändern, klicken Sie auf „Zurück“.

Wenn eine Fehlermeldung angezeigt wird

Prüfen Sie die folgende Liste auf mögliche Fehler. Zum Schließen der Meldung, klicken Sie auf „OK“.

- Prüfen Sie, ob der CD-Schlüssel und die interne Maschinenummer (No.) richtig eingegeben worden sind und wiederholen Sie den Vorgang ab Schritt **3**.
- Der CD-Schlüssel gilt nur für die Verwendung mit einer bestimmten internen Maschinenummer (No.). Prüfen Sie, dass der CD-Schlüssel richtig eingegeben worden ist und wiederholen Sie den Vorgang ab Schritt **3**.
- Überprüfen Sie die Internetverbindung und klicken Sie anschließend erneut auf „Bestätigen“.



- 11** Notieren Sie den angezeigten 8-stelligen Bestätigungsschlüssel.

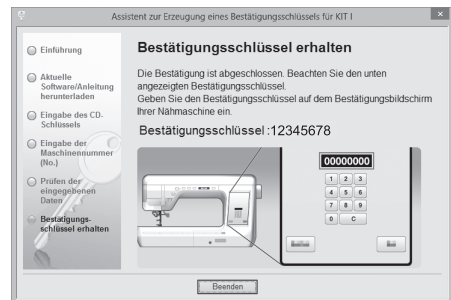

Hinweis

- Nach der Aktualisierung der Nähmaschine mit KIT I muss der Bestätigungsschlüssel im Einstellungsbildschirm der Nähmaschine eingegeben werden.



- 12** Klicken Sie auf „Beenden“.

Der Bestätigungsschlüssel wurde erfolgreich bezogen.

Fahren Sie jetzt mit der Installation des Aktualisierungsprogramms für KIT I auf der Nähmaschine fort.

Verwenden Sie zur Installation des Aktualisierungsprogramms ein USB-Medium oder einen Computer mit Kabelverbindung zur Maschine.

Wenn ein **USB-Medium** benutzt wird, folgen Sie den nachstehenden Anweisungen.

Wenn Sie einen **Computer** verwenden, siehe Prozedurbeschreibung auf Seite 8.

Wenn ein USB-Medium für die Installation benutzt wird



- 13** Halten Sie die Taste „Automatisches Einfädeln“ gedrückt und schalten Sie die Nähmaschine ein.



- 14** Kopieren Sie das in Schritt **6** heruntergeladene Aktualisierungsprogramm auf das USB-Medium.



Hinweis

- Kopieren Sie ausschließlich das Aktualisierungsprogramm auf ein neu formatiertes USB-Medium; es dürfen keine anderen Dateien auf diesem Medium enthalten sein.



- 15** Drücken Sie  .

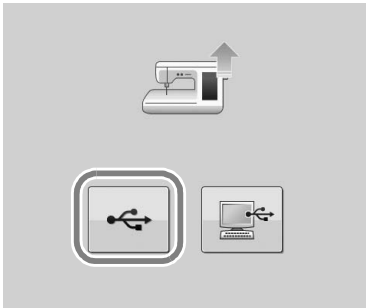

- 16** Setzen Sie das USB-Medium in den Primär-USB-Anschluss (oben) rechts an der Maschine ein. Es dauert ein paar Sekunden, bis die Maschine erkennt, dass ein USB-Medium in den Anschluss eingesetzt ist.



- 17** Drücken Sie  .



Hinweis

Wenn die Meldung „**Aktualisierung abgeschlossen.**“ erscheint, ist die Installation des Aktualisierungsprogramms abgeschlossen. (Wenn ein Fehler aufgetreten ist, wird eine rote Fehlermeldung angezeigt.)



- 18** Entfernen Sie das USB-Medium.

Weiter mit Schritt **19** auf Seite 9.

Wenn ein Computer zur Installation benutzt wird



- 13 Halten Sie die Taste „Automatisches Einfädeln“ gedrückt und schalten Sie die Nähmaschine ein.



- 14 Drücken Sie .

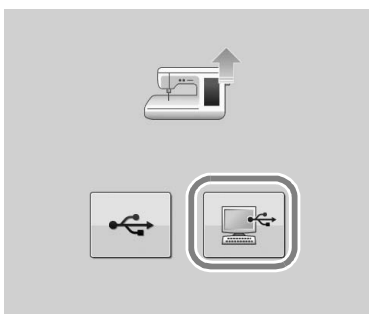

- 15 Stecken Sie das USB-Kabel in die entsprechenden USB-Anschlussbuchsen am Computer und an der Maschine ein.

→ **Wechseldatenträger** erscheint unter **Computer (Arbeitsplatz)**.



Hinweis

- Verbinden Sie kein weiteres USB-Medium mit dem Computer, wenn Sie ein USB-Kabel verwenden.



- 16 Kopieren Sie das in Schritt 6 heruntergeladene Aktualisierungsprogramm auf den **Wechseldatenträger**.

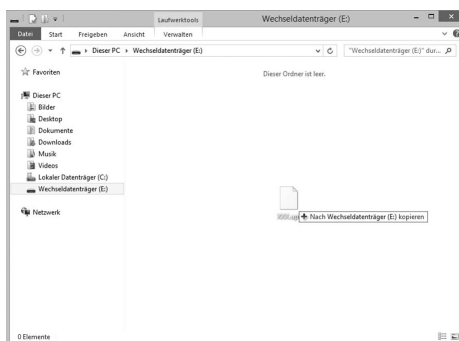

Hinweis

- Die Meldung „**Aktive PC-Verbindung. Das USB-Kabel nicht trennen.**“ erscheint auf dem LCD-Bildschirm der Nähmaschine.



- 17 Drücken Sie .



Hinweis

- Wenn die Meldung „**Aktualisierung abgeschlossen.**“ erscheint, ist die Installation des Aktualisierungsprogramms abgeschlossen. (Wenn ein Fehler aufgetreten ist, wird eine rote Fehlermeldung angezeigt.)



18 Ziehen Sie das USB-Kabel aus der USB-Anschlussbuchse.



19 Schalten Sie die Maschine aus und wieder ein.

20 Rufen Sie Seite 4 oder 7 des Einstellungsbildschirms auf.



21 Drücken Sie **ZERTIFIZIERUNG** im Einstellungsbildschirm.



22 Drücken Sie **KIT 1** auf dem folgenden Bildschirm.

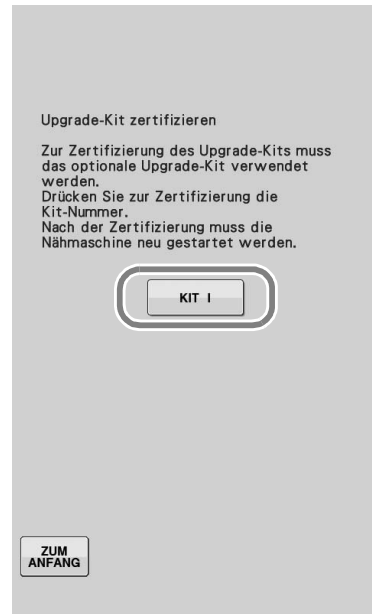

23 Geben Sie den 8-stelligen Bestätigungsschlüssel ein, den Sie in Schritt 11 notiert haben, und drücken Sie dann **EINSTELLEN**.

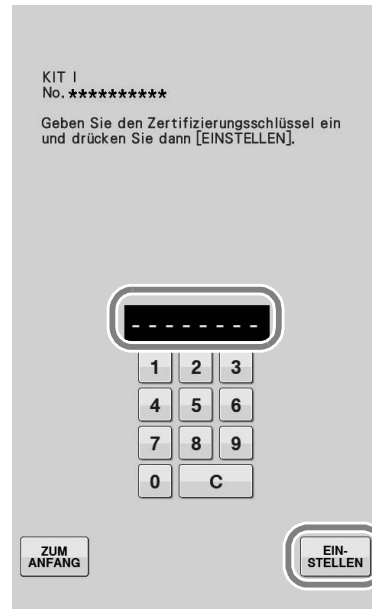



- 24** Die Bestätigung ist abgeschlossen, wenn der folgende Bildschirm angezeigt wird. Schalten Sie die Nähmaschine aus und dann wieder ein.

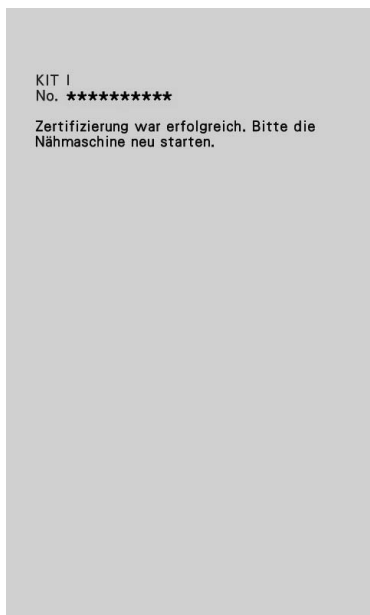

- 25** Prüfen Sie, dass „KIT I“ im Einstellungsbildschirm mit einem Häkchen gekennzeichnet ist.

- Das „KIT I“ wurde erfolgreich bestätigt.

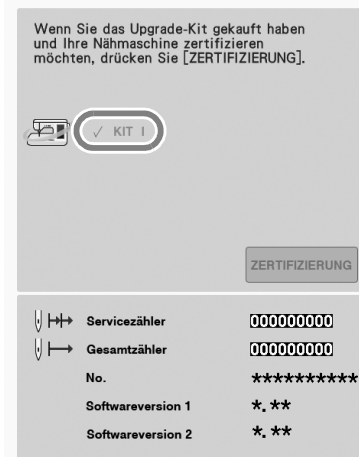

Hinweis

- Wenn der folgende Bildschirm erscheint, geben Sie den 8-stelligen Bestätigungsschlüssel ein, den Sie in Schritt **11** notiert haben, und drücken Sie dann

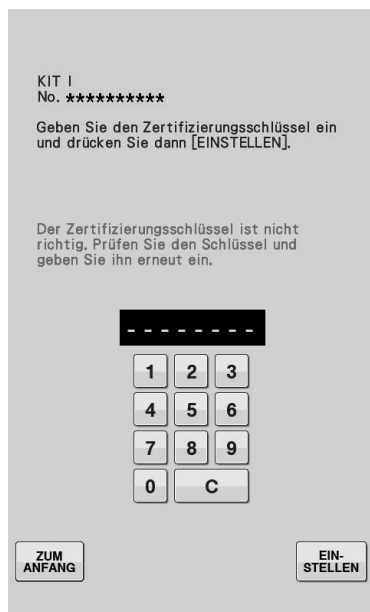

- Wenn Sie den Bestätigungsschlüssel verlieren, wiederholen Sie die Schritte **2** bis **12**, um den Bestätigungsschlüssel wieder zu erhalten.



Hinweis

- Ausführliche Informationen zu den aktualisierten Funktionen finden Sie in der mit dem Assistenten zur Erzeugung eines Bestätigungsschlüssels heruntergeladenen Bedienungsanleitung (PDF-Version).

Informationen zum Herunterladen der Bedienungsanleitung finden Sie auf Seite 5.

TABLE DES MATIÈRES

Accessoires	2
Utilisation des manuels	2
Vue d'ensemble de l'installation.....	3
Configuration requise de l'ordinateur	3
Procédure d'installation.....	4

Accessoires

Les accessoires suivants sont inclus à l'achat. Vérifiez que tous les éléments sont fournis. Si un élément est manquant ou endommagé, contactez votre revendeur agréé.

- **CD-ROM**
Le CD-ROM contient les fichiers suivants.
 - L'Assistant de délivrance de code de certification
Respectez la procédure de ce guide d'installation pour mettre votre machine à niveau.
 - 30 motifs de broderie
 - Guide de motifs de broderie (version PDF)



- Guide d'installation (le présent guide)

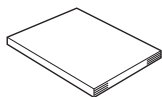

- Jeu de cadre de broderie
H 30 cm x L 20 cm (H 12 pouces x L 8 pouces)
Une fois le KIT activé, vous pouvez utiliser ce cadre de broderie et la zone de broderie maximale devient plus large que sur les cadres précédents fournis avec votre machine. Vous pouvez utiliser ce cadre de broderie pour broder plusieurs motifs enregistrés sur le CD-ROM fourni.

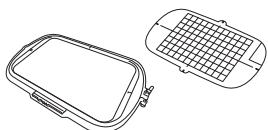

- Jeu de cadre de broderie
H 20 cm x L 20 cm (H 8 pouces x L 8 pouces)
Ce cadre de broderie est idéal pour le quilting (courtepointe).



Utilisation des manuels

- **Guide d'installation (le présent manuel)**
Ce guide présente les accessoires et les procédures de mise à niveau de la machine.
- **Manuel d'instructions (version PDF)**
Ce manuel fournit des instructions sur l'utilisation de la machine avec les fonctions et accessoires ajoutés.
Veillez à utiliser la machine et les accessoires fournis tel que décrit dans le manuel d'instructions.
Adobe Reader est requis pour afficher et imprimer le manuel d'instructions.





Remarque

- Téléchargez une copie du manuel d'instructions à l'aide de l'Assistant de délivrance de code de certification à l'étape 7 de la page 5.

Vue d'ensemble de l'installation

Obtenez un code de certification à l'aide de l'Assistant de délivrance de code de certification inclus sur le CD-ROM. Utilisez ensuite le code de CERTIFICATION sur l'écran des réglages, à la page 4 ou 7, pour activer l'application de mise à niveau pour le KIT I de la machine à coudre.

Dans les procédures,  indique des opérations réalisées avec la machine à coudre et  des opérations effectuées avec un ordinateur.



[Étape 1] Notez le numéro d'identification interne de la machine (No.).



[Étape 2] Insérez le CD-ROM dans le lecteur correspondant de l'ordinateur, puis démarrez l'Assistant de délivrance de code de certification.



[Étape 3] Suivez les instructions de l'Assistant pour obtenir le code de certification.



[Étape 4] Installez l'application de mise à niveau pour le KIT I sur la machine à coudre.



[Étape 5] Mettez la machine hors tension, retirez le support USB, puis remettez la machine sous tension.



[Étape 6] Une fois la mise à niveau correctement installée, certifiez le « KIT I » dans l'écran des réglages de la machine à coudre.

Configuration requise de l'ordinateur

Avant de lancer l'Assistant de délivrance de code de certification, vérifiez que l'ordinateur à connecter répond aux conditions d'utilisation suivantes.

Ordinateur	Ordinateur IBM ou ordinateur compatible
Système d'exploitation	Windows Vista, Windows 7, 8, 8.1 (32 ou 64 bits)
Lecteur de CD-ROM	Requis pour l'installation
Autres	Connexion Internet et un port USB disponible (requis pour la mise à niveau de la machine à coudre) lorsque vous utilisez un ordinateur

* « IBM » est une marque déposée d'IBM Corporation aux États-Unis et dans d'autres pays.

* « Windows » et « Windows Vista » sont des marques déposées de Microsoft Corporation aux États-Unis et dans d'autres pays.

* « Adobe » et « Adobe Reader » sont des marques de commerce ou des marques déposées d'Adobe Systems Incorporated aux États-Unis et/ou dans d'autres pays.

* Chaque société dont le nom de logiciel est mentionné dans ce guide dispose d'un contrat de licence de logiciel spécifique à ses programmes propriétaires.

Tous les autres noms de produit et marques cités dans ce guide sont des marques déposées de leurs entreprises respectives.

Toutefois, les explications relatives aux marquages [®] et [™] ne figurent pas clairement dans le texte.

Procédure d'installation

La procédure suivante décrit comment mettre à niveau votre machine à coudre pour le KIT I.



Remarque

- Si la procédure décrite ci-dessous n'est pas complètement terminée, votre machine à coudre ne pourra pas être mise à niveau pour le KIT I.
- L'accès à Internet est requis pour télécharger le programme de mise à niveau et obtenir un code de certification.



- 1 Notez le numéro à 10 chiffres (numéro d'identification interne de la machine) affiché à côté de « No. » à la page 4 ou 7 de l'écran des réglages.



Mémo

- Vérifiez que le numéro d'identification interne de la machine (No.) est correctement saisi car ces numéros doivent être entrés dans l'Assistant de délivrance de code de certification pour obtenir le code de certification.

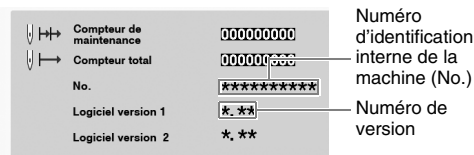

* Le nombre de pages dans l'écran des réglages peut varier en fonction de la version.



Remarque

- Le numéro d'identification interne de la machine qui apparaît à côté de « No. » est différent du numéro de série (NO. SER.) figurant sur l'étiquette apposée à l'arrière de la machine à coudre.



- 2 Insérez le CD-ROM dans le lecteur correspondant de l'ordinateur.



Mémo

- Dans Windows 7 ou Windows Vista, lorsque la boîte de dialogue **Exécution automatique** s'affiche, cliquez sur **Ouvrir le dossier pour visualiser les fichiers**.
- Sous Windows 8 ou 8.1, cliquez sur le message **Cliquez pour sélectionner l'action à exécuter avec ce disque**, qui apparaît à l'écran.



- 3 Ouvrez le lecteur correspondant à votre CD-ROM (généralement le lecteur « D ») sur l'**Ordinateur (Poste de travail)**, double-cliquez sur pour lancer l'**Assistant de délivrance de code de certification**.



Mémo

- La procédure suivante peut être utilisée pour lancer l'Assistant de délivrance de code de certification.
 1. Cliquez sur **Démarrer**.
 2. Cliquez sur **Exécuter** ou, dans la zone de recherche, tapez « exécuter », puis, dans la liste des résultats, cliquez sur **Exécuter**.→ La boîte de dialogue **Exécuter** s'affiche.
 3. Tapez le chemin d'accès vers le fichier d'application (**D:\KeyWizard_KIT1.exe**), puis cliquez sur **OK**.

→ La boîte de dialogue **Select Language (Sélectionner une langue)** s'affiche automatiquement.



- 4 Sélectionnez la langue souhaitée, puis cliquez sur « **OK** ».



→ L'**Assistant de délivrance de code de certification du KIT I** s'affiche.



- 5 Lisez attentivement les informations qui s'affichent, puis cliquez sur « **Suivant** ».

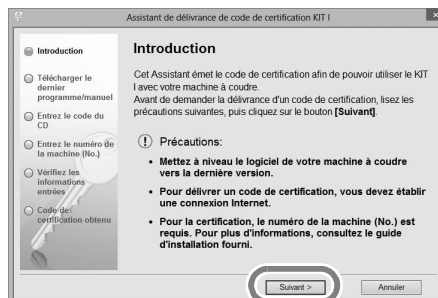



- 6** Téléchargez le dernier programme de mise à niveau. Confirmez le modèle de votre machine, cliquez sur « **Télécharger** », puis enregistrez le programme de mise à niveau (*****.upf) sur votre ordinateur. Cliquez sur « **Suivant** ».

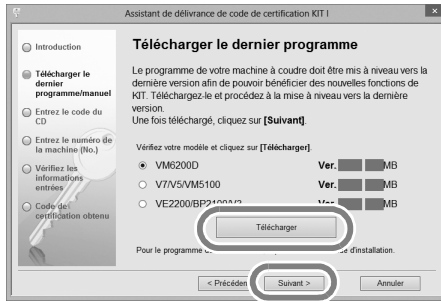

Cliquez sur « **OK** » pour fermer le message ci-dessous.



Remarque

- Si la version affichée, ou une version ultérieure, a déjà été installée sur la machine (reportez-vous à l'étape **1** à la page 4), cliquez sur « **Suivant** » pour poursuivre la procédure sans télécharger le fichier le plus récent. Suivez les étapes **8** à **12** et ignorez les étapes **13** à **18**, puis recommencez à suivre la procédure à partir de l'étape **19** de la page 9.



- 7** Téléchargez le manuel. Sélectionnez la langue de votre choix et cliquez sur « **Télécharger** » pour enregistrer le fichier sur votre ordinateur, puis cliquez sur « **Suivant** ».

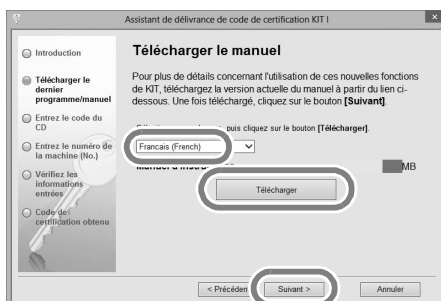

- 8** Tapez le code à 15 chiffres du CD figurant sur l'étiquette apposée sur l'enveloppe du CD-ROM au kit de mise à niveau, puis cliquez sur « **Suivant** ».

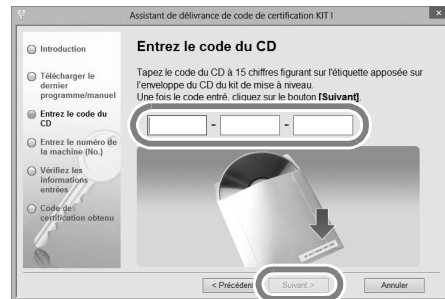

Remarque

- Tapez le code du CD figurant sur l'étiquette apposée sur l'enveloppe du CD-ROM pour les machines.

Si un message d'erreur s'affiche

Consultez la liste ci-dessous pour connaître les erreurs possibles. Pour fermer le message, cliquez sur « **OK** ».

- Des symboles ou des caractères autres que des lettres et des numéros ont-ils été entrés?
- La lettre majuscule « **I** » a-t-elle été entrée à la place du chiffre « **1** »?
- La lettre majuscule « **O** » a-t-elle été entrée à la place du chiffre « **0** »?

Mémo

- Les lettres majuscules « **O** » et « **I** » ne sont pas utilisées dans le code du CD. De même, aucun symbole n'est utilisé dans le code du CD.



- 9 Tapez le numéro d'identification interne de la machine (No.) noté à l'étape 1, puis cliquez sur « **Suivant** ».



Si un message d'erreur s'affiche

Vérifiez que des symboles ou des caractères autres que des numéros n'ont pas été entrés. Pour fermer le message, cliquez sur « **OK** ».



- 10 Vérifiez attentivement que les informations ont été entrées correctement, puis cliquez sur « **Certifier** ».

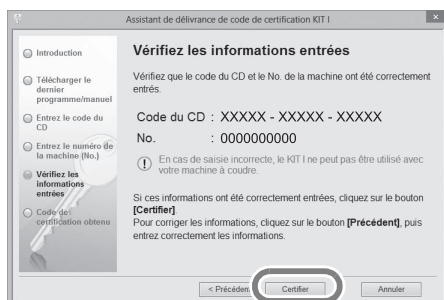

Mémo

- Pour modifier les informations entrées, cliquez sur « **Précédent** ».

Si un message d'erreur s'affiche

Consultez la liste ci-dessous pour connaître les erreurs possibles. Pour fermer le message, cliquez sur « **OK** ».

- Vérifiez que le code du CD et le numéro d'identification interne de la machine (No.) ont été entrés correctement, puis répétez la procédure à partir de l'étape 3.
- Le code du CD ne peut être utilisé qu'avec un seul numéro d'identification interne de la machine (No.). Vérifiez que le code du CD a été entré correctement, puis répétez la procédure à partir de l'étape 3.
- Vérifiez la connexion Internet, puis cliquez de nouveau sur « **Certifier** ».



- 11 Notez le code de certification à 8 chiffres qui apparaît.



Remarque

- Après la mise à niveau de la machine à coudre vers le KIT I, le code de certification doit être entré sur l'écran des réglages de la machine à coudre.



- 12 Cliquez sur « **Terminer** ».

Le code de certification a bien été obtenu.

Installez maintenant l'application de mise à niveau pour le KIT I sur la machine à coudre.

Installez-la à partir d'un support USB ou d'un ordinateur.

Si vous utilisez le **support USB**, respectez la procédure qui suit.

Si vous utilisez un **ordinateur**, reportez-vous à la procédure décrite à la page 8.

Lorsque vous utilisez le support USB pour procéder

à l'installation



- 13 Tout en appuyant sur la touche « Enfilage automatique », mettez la machine sous tension.



- 14 Copiez le programme de mise à niveau téléchargé à l'étape 6 sur le support USB.



Remarque

- Copiez uniquement le programme de mise à niveau sur un support USB reformaté et nettoyé; aucun autre fichier ne doit figurer sur ce support.



- 15 Appuyez sur .

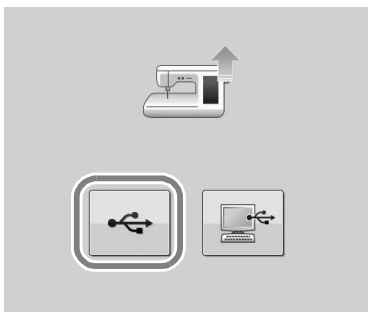

- 16 Insérez le support USB dans le connecteur de port USB principal (supérieur) sur le côté droit de la machine. La machine prendra quelques secondes à reconnaître que le support USB a été inséré dans le port.



- 17 Appuyez sur .



Remarque

- Lorsque le message « **Mise à niveau terminée.** » s'affiche, l'installation de l'application de mise à niveau est terminée. (En cas d'erreur, un message s'affiche en rouge.)



- 18 Retirez le support USB.

Passez à l'étape 19 à la page 9.

Lorsque vous utilisez un ordinateur pour procéder à

l'installation



13 Tout en appuyant sur la touche « Enfilage automatique », mettez la machine sous tension.



14 Appuyez sur .

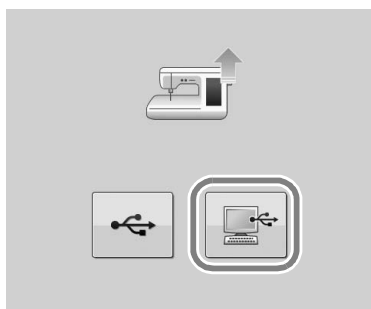

15 Branchez les prises du câble USB dans les connecteurs de port USB correspondants de l'ordinateur et de la machine.

→ Le **Disque amovible** apparaît sous **Ordinateur (Poste de travail)**.



Remarque

- Ne connectez pas d'autres supports USB à votre ordinateur lorsque vous utilisez le câble USB.



16 Copiez le programme de mise à niveau téléchargé à l'étape 6 sur le **Disque amovible**.

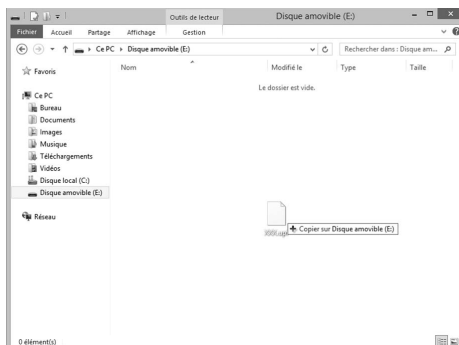

Remarque

- Le message « **Connecté à un PC. Ne déconnectez pas le câble USB.** » apparaît sur l'écran à cristaux liquides de la machine à coudre.



17 Appuyez sur .



Remarque

- Lorsque le message « **Mise à niveau terminée.** » s'affiche, l'installation de l'application de mise à niveau est terminée. (En cas d'erreur, un message s'affiche en rouge.)



18 Débranchez le câble USB.



19 Mettez la machine à coudre hors tension puis sous tension à nouveau.

20 Affichez la page 4 ou 7 de l'écran des réglages.



21 Appuyez sur **CERTIFIC.** dans l'écran des réglages.



22 Appuyez sur **KIT 1** dans l'écran suivant.



23 Tapez le code de certification à 8 chiffres noté à l'étape 11, puis appuyez sur **REGLER**.

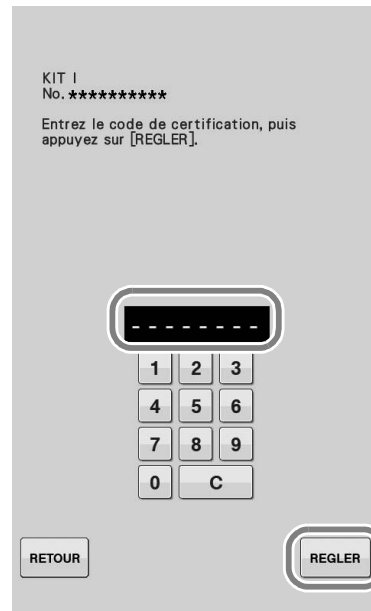



- 24** La certification est terminée lorsque l'écran suivant s'affiche. Mettez la machine à coudre hors tension puis sous tension à nouveau.

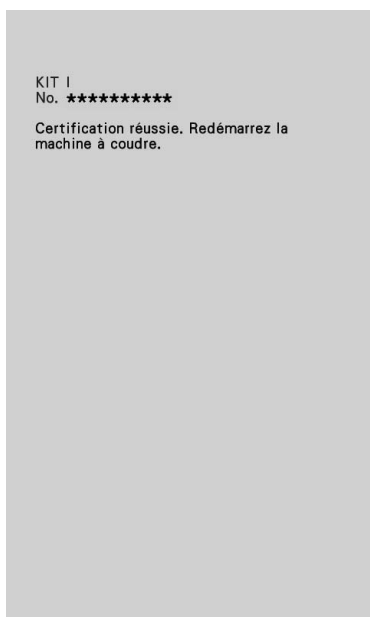

- 25** Vérifiez que la case « KIT I » est bien cochée dans l'écran des réglages.

- Le « KIT I » a bien été certifié.

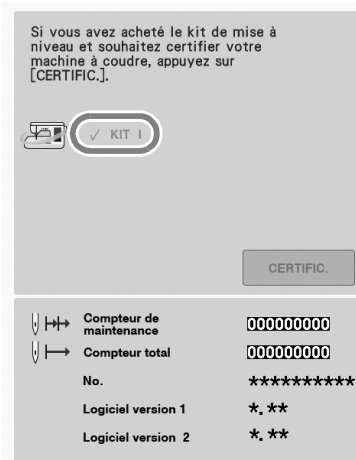

Remarque

- Si l'écran suivant s'affiche, tapez le code de certification à 8 chiffres noté à l'étape 11, puis appuyez sur **REGLER**.

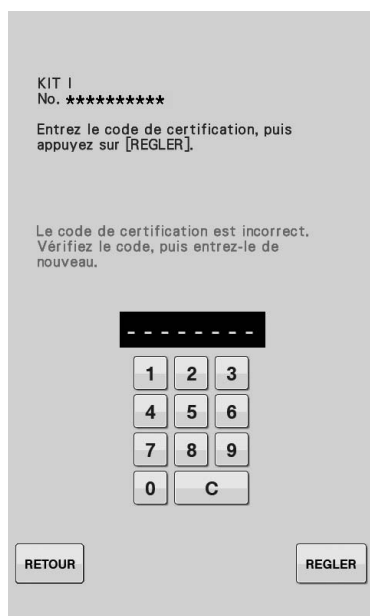

- Si vous avez perdu le code de certification, répétez les étapes 2 à 12 pour l'obtenir de nouveau.



Remarque

- Pour plus de détails sur les fonctions mises à niveau, consultez le manuel d'instructions (version PDF) téléchargé à l'aide de l'Assistant de délivrance de code de certification.

Reportez-vous à la page 5 pour plus d'informations sur le téléchargement du manuel d'instructions.

INHOUDSOPGAVE

Accessoires	2
Werken met de handleidingen	2
Installatieoverzicht	3
Computervereisten	3
Installatieprocedure	4

Accessoires

Uw aankoop bevat de volgende artikelen. Controleer de inhoud van het pakket. Neem contact op met uw erkende dealer als er iets ontbreekt of beschadigd is.

- Cd-rom
De cd-rom bevat onderstaande bestanden:
 - De Wizard uitgifte certificatiesleutel
Volg de procedure in deze Installatie handleiding om een upgrade uit te voeren op uw machine.
 - 30 borduurontwerpen
 - Borduurmotieven handleiding (PDF-versie)



- Installatie handleiding (deze handleiding)

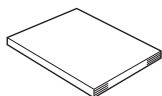

- Borduurraamset
H 30 cm × B 20 cm (H 12 inch × B 8 inch)
Nadat de KIT is geactiveerd, kunt u dit borduurraam gebruiken. Het maximale borduurgebied is groter dan bij eerdere ramen bij de machine. Meerdere patronen op deze cd-rom kunt u borduren met dit borduurraam.

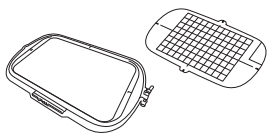

- Borduurraamset
H 20 cm × B 20 cm (H 8 inch × B 8 inch)
Dit borduurraam is ideaal om te quilten.



Werken met de handleidingen

- **Installatie handleiding (deze handleiding)**
In deze handleiding vindt u beschrijvingen van de accessoires en procedures voor de upgrade van de machine.
- **Bedieningshandleiding (PDF-versie)**
In de Bedieningshandleiding vindt u beschrijvingen voor het gebruik van de machine met de toegevoegde functies en accessoires. Gebruik de machine en de bijbehorende accessoires volgens de beschrijvingen in de Bedieningshandleiding.
U hebt Adobe Reader nodig om de Bedieningshandleiding te bekijken en af te drukken.





Opmerking

- Download een kopie van Bedieningshandleiding met de Wizard uitgifte certificatiesleutel in stap 7 op pagina 5.

Installatieoverzicht

Haal eerst een certificatiesleutel op met de Wizard uitgifte certificatiesleutel op de bijgesloten cd-rom.

Vervolgens activeert u met de toets CERTIFICATIE in het instellingenschermb, pagina 4 of 7, de upgradetoepassing voor KIT I op de naaimachine.

In het gedeelte Procedures wordt met  aangegeven dat de bewerkingen worden uitgevoerd op de naaimachine; met  wordt aangegeven dat de bewerkingen worden uitgevoerd met de computer.



[Stap 1] Noteer het interne machine-identificatienummer (No.).



[Stap 2] Plaats de cd-rom in het cd-romstation van de computer en start vervolgens de Wizard uitgifte certificatiesleutel.



[Stap 3] Volg de aanwijzingen van de wizard om de certificatiesleutel op te halen.



[Stap 4] Installeer de upgradetoepassing voor KIT I op de naaimachine.



[Stap 5] Schakel de machine uit, verwijder de USB-medium en schakel de machine weer in.



[Stap 6] Nadat u de upgrade hebt geïnstalleerd, certificeert u "KIT I" in het Instellingenschermb van de naaimachine.

Computervereisten

Alvorens de Wizard uitgifte certificatiesleutel te starten, controleert u of de aan te sluiten computer voldoet aan de volgende vereisten.

Computer	IBM-pc of compatibele computer
Besturingssysteem	Windows Vista, Windows 7, 8, 8.1 (32- of 64-bits)
Cd-romstation	Vereist voor installatie
Overige	Internetaansluiting en één beschikbare USB-poort (vereist om de upgrade van de naaimachine uit te voeren) wanneer u een computer gebruikt

- * "IBM" is een gedeponeerd handelsmerk van IBM Corporation in de Verenigde Staten en andere landen.
- * "Windows" en "Windows Vista" zijn gedeponeerde handelsmerken van Microsoft Corporation in de Verenigde Staten en andere landen.
- * "Adobe" en "Adobe Reader" zijn gedeponeerde handelsmerken of handelsmerken van Adobe Systems Incorporated in de Verenigde Staten en/of andere landen.
- * Elk bedrijf waarvan de software in deze handleiding is vermeld, heeft een softwaregebruiksrechtsovereenkomst met betrekking tot zijn speciale programma's. Alle andere merk- en productnamen die worden genoemd in deze handleiding, zijn gedeponeerde handelsmerken van hun respectievelijke bedrijven. De uitleg van tekens zoals ® en ™ is niet duidelijk aangegeven in de tekst.

Installatieprocedure

In onderstaande procedure wordt beschreven hoe u de upgrade van uw naaimachine naar KIT I uitvoert.

Opmerking

- Wanneer u onderstaande procedure niet volledig voltooit, wordt de upgrade van uw machine naar KIT I niet uitgevoerd.
- U hebt een internetverbinding nodig om het upgradeprogramma te downloaden en een certificatiesleutel op te halen.



- 1 Noteer het 10-cijferige nummer (intern machine-identificatienummer) dat wordt weergegeven naast "No." op pagina 4 of 7 van het instellingscherm.

Memo

- Zorg dat u het interne machine-identificatienummer (No.) goed noteert. U moet deze nummers invoeren in de wizard Uitgifte certificatiesleutel om de certificatiesleutel op te halen.

Serviceherinnering	0000000000	Intern machine-identificatienummer (No.)
Totaalaantal	0000000000	
No.	*****	Versie-nummer
Softwareversie 1	* **	
Softwareversie 2	* **	

* Het aantal pagina's in het Instellingscherm kan variëren naargelang de versie.

Opmerking

- Het interne machine-identificatienummer naast "No." is niet hetzelfde als het serienummer van de machine (SER. NO.) op het etiket op de achterkant van de naaimachine.



- 2 Plaats de cd-rom in het cd-romstation van de computer.

Memo

- Wanneer in Windows 7 of Windows Vista het dialoogvenster **Automatisch afspelen** verschijnt, klikt u op **Map openen om bestanden weer te geven**.
- In Windows 8 of 8.1 klikt u op het bericht **"Tik hier om aan te geven wat u wilt doen met deze schijf"** dat op het scherm verschijnt.



- 3 Open het station dat is toegewezen aan uw cd-rom (doorgaans station "D") op de **Computer (Deze computer)**, dubbelklik op  om de **Wizard uitgifte certificatiesleutel** te starten.

Memo

- U kunt de Wizard uitgifte certificatiesleutel starten volgens onderstaande procedure.
 1. Klik op **Opstarten (Start)**.
 2. Klik op **Uitvoeren** of typ "uitvoeren" in het zoekvak en klik op **Uitvoeren** in de lijst resultaten.→ Het dialoogvenster **Uitvoeren** verschijnt.
 3. Typ het pad naar het toepassingsbestand (**D:\KeyWizard_KIT1.exe**) en klik op **OK**.

→ Het dialoogvenster **Select Language (Selecteer taal)** verschijnt automatisch.



- 4 Selecteer de gewenste taal en klik op **"OK"**.

Select Language

- English
- Deutsch (German)
- Français (French)
- Nederlands (Dutch)
- Italiano (Italian)
- Español (Spanish)
- 中文 (Chinese)

Cancel OK

→ **KIT I Wizard uitgifte certificatiesleutel** verschijnt.



- 5 Lees de informatie die verschijnt zorgvuldig en klik op **"Volgende"**.

Wizard uitgifte certificatiesleutel KIT I

Inleiding

Deze wizard geeft de certificatiecode uit, zodat u KIT I kunt gebruiken met uw naaimachine. Alvorens te verzoeken om een certificatiesleutel, dient u de volgende voorzorgsmaatregelen te lezen. Vervolgens klikt u op de toets: [Volgende]

! Voorzorgsmaatregelen:

- Zorg dat u beschikt over de nieuwste software-upgrade voor uw naaimachine.
- Om een certificatiesleutel te verkrijgen, moet u verbinding maken met internet.
- Voor de certificatie hebt u het machinenummer (No.) nodig. Bijzonderheden vindt u in de bijgesloten Installatiegids.

Volgende > Annuleren



- 6** Download het meest recente upgradeprogramma.
Bevestig het model van uw machine, klik op **“Laden”** en sla het upgradeprogramma (*****.upf) op uw computer op. Klik op **“Volgende”**.



Klik op **“OK”** om onderstaand bericht te sluiten.



Opmerking

- Als de weergegeven versie of een latere versie al is geïnstalleerd op de machine (zie stap 1 op pagina 4), klik dan op **“Volgende”** om de procedure te vervolgen zonder het nieuwste bestand te downloaden. Volg stap 8 t/m 12, sla stap 13 t/m 18 over en start de procedure vanaf stap 19 op pagina 9.



- 7** Download de handleiding.
Selecteer de gewenste taal en klik op **“Laden”** om het bestand op te slaan op uw computer. Klik op **“Volgende”**.



- 8** Typ de 15-cijferige cd-sleutel over van het etiket op het cd-hoesje van de upgrade kit en klik op **“Volgende”**



Opmerking

- Typ de cd-sleutel over van het etiket op het cd-hoesje voor machines.

Als een foutbericht verschijnt

Controleer onderstaande lijst op mogelijke typfouten. Als u het bericht wilt sluiten, klikt u op **“OK”**.

- Hebt u andere symbolen of tekens ingevoerd dan letters of cijfers?
- Hebt u een hoofdletter “l” ingevoerd in plaats van het cijfer “1”?
- Hebt u een hoofdletter “O” ingevoerd in plaats van het cijfer “0”?

Memo

- De hoofdletters “l” en “O” worden niet gebruikt in de cd-sleutel. In de cd-sleutel worden ook geen symbolen gebruikt.



- 9 Typ het interne machine-identificatienummer (No.) dat u hebt genoteerd in stap 1 en klik op **“Volgende”**.

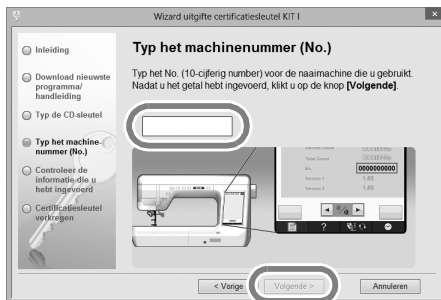

Als een foutbericht verschijnt

Controleer of u andere symbolen of letters hebt getypt dan cijfers. Als u het bericht wilt sluiten, klikt u op **“OK”**.



- 10 Controleer of u de sleutel juist hebt ingevoerd en klik op **“Certificatie”**.

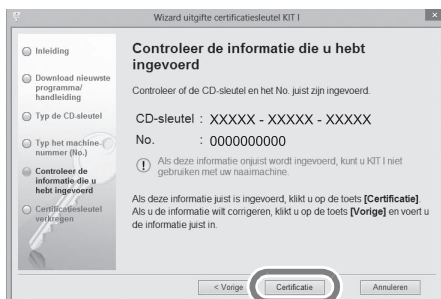

Memo

- Als u de opgegeven informatie wilt wijzigen, klikt u op **“Vorige”**.

Als een foutbericht verschijnt

Controleer onderstaande lijst op mogelijke fouten. Als u het bericht wilt sluiten, klikt u op **“OK”**.

- Controleer of de cd-sleutel en het interne machine-identificatienummer (No.) juist zijn ingevoerd en herhaal de procedure vanaf stap 3.
- De cd-sleutel is alleen geldig voor één intern machine-identificatienummer (No.). Controleer of de cd-sleutel juist is ingevoerd en herhaal de procedure vanaf stap 3.
- Controleer de internetverbinding en klik opnieuw op **“Certificatie”**.



- 11 Noteer de 8-cijferige certificatiesleutel die verschijnt.



Opmerking

- Nadat u de upgrade van de borduurmachine naar KIT I hebt uitgevoerd, moet u de certificatiesleutel invoeren in het Instellingenscherf van de naaimachine.



- 12 Klik op **“Voltoeien”**.

De certificatiesleutel is opgehaald.

Installeer nu de upgradetoepassing voor KIT I op de naaimachine.

Installeer de upgradetoepassing met een **USB-medium** of een computer.

Volg onderstaande instructies, als u een **USB-medium** gebruikt.

Als u een **computer** gebruikt, volgt u de procedure op pagina 8.

Wanneer u de installatie uitvoert met een USB-medium



- 13 Terwijl u de “Automatisch inrijgtoets” ingedrukt houdt, zet u de machine aan.



- 14 Kopieer het upgradeprogramma dat u hebt gedownload in stap 6 naar het USB-medium.



Opmerking

- Kopieer alleen het upgradeprogramma naar een schoon, opnieuw geformatteerd USB-medium. Op dit medium mogen zich geen andere bestanden bevinden.



- 15 Druk op  .

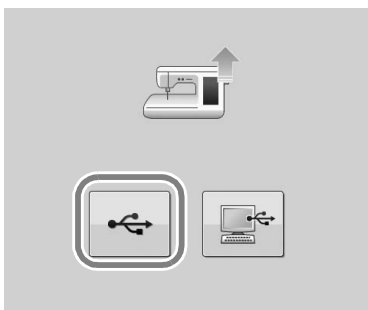

- 16 Plaats het USB-medium in de primaire (bovenste) USB-poort op de rechterkant van de machine. Het duurt enkele seconden voordat de machine het USB-medium herkent.



- 17 Druk op  .



Opmerking

- Wanneer het bericht “**Upgrade voltooid.**” wordt weergegeven, is de installatie van de upgrade-applicatie voltooid. (Als zich een fout heeft voorgedaan, verschijnt een foutmelding in rode letters.)



- 18 Verwijder het USB-medium.

Ga verder met stap 19 op pagina 9.

Wanneer u de installatie uitvoert met een computer



- 13 Terwijl u de “Automatisch inrijgtoets” ingedrukt houdt, zet u de machine aan.



- 14 Druk op .

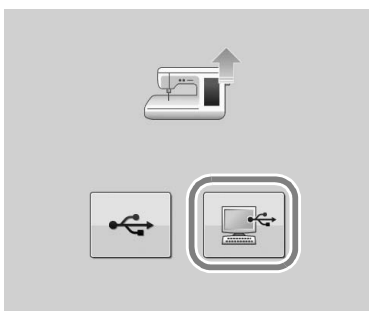

- 15 Sluit de USB-kabel aan op de betreffende USB-poortaan sluiting op de computer en op de machine.

→ **Verwisselbare schijf** verschijnt in **Computer (Deze computer)**.

Opmerking

- Sluit geen andere USB-media op uw computer aan terwijl u de USB-kabel gebruikt.



- 16 Kopieer het upgradeprogramma dat u hebt gedownload in stap 6 naar de **Verwisselbare schijf**.

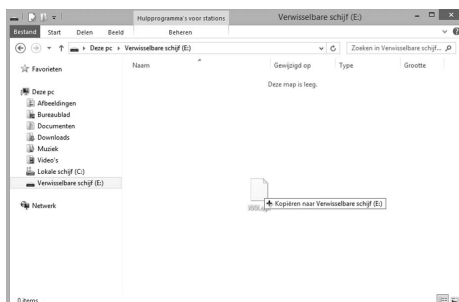

Opmerking

- Het bericht “**Aangesloten op pc. Maak de USB-kabel niet los.**” verschijnt op het LCD-scherm van de naaimachine.



- 17 Druk op .



Opmerking

- Wanneer het bericht “**Upgrade voltooid.**” wordt weergegeven, is de installatie van de upgrade-applicatie voltooid. (Als zich een fout heeft voorgedaan, verschijnt een foutmelding in rode letters.)



18 Verwijder de USB-kabel.



19 Zet de machine uit en weer aan.

20 Open pagina 4 of 7 van het instellingenschermb.



21 Druk op **CERTIFICATIE** in het instellingenschermb.



22 Druk op **KIT I** in het volgende scherm.



23 Typ de 8-cijferige certificatiesleutel die u hebt genoteerd in stap 11 en druk op **INSTELLEN**.





- 24** De certificatie is voltooid wanneer het volgende scherm verschijnt. Zet de machine uit en weer aan.

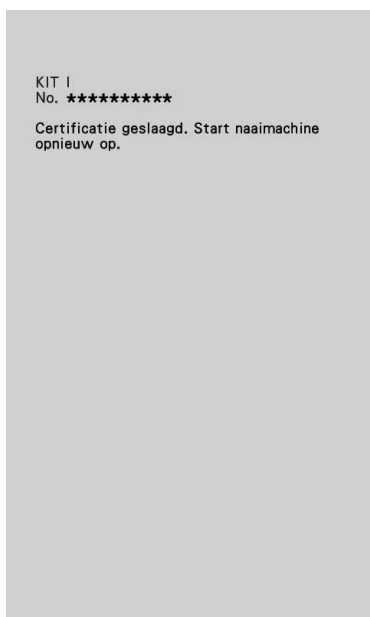

- 25** Controleer of in het Instellingenschermb een vinkje naast "KIT I" staat.
- "KIT I" is gecertificeerd.



Opmerking

- Als onderstaand scherm verschijnt, typ de 8-cijferige certificatiesleutel die u hebt genoteerd in stap **11** en druk op **INSTELLEN**.



- Als u de certificatiesleutel kwijt bent, herhaalt u stap **2** t/m **12** om de certificatiesleutel te verkrijgen.



Opmerking

- Meer informatie over de functies van de upgrade vindt u in de Bedieningshandleiding (PDF-versie) die u hebt gedownload met de Wizard uitgifte certificatiesleutel.

Op pagina 5 vindt u informatie over het downloaden van de Bedieningshandleiding.

SOMMARIO

Accessori.....	2
Utilizzo dei manuali.....	2
Panoramica dell'installazione.....	3
Requisiti del computer	3
Procedura d'installazione	4

Accessori

Con l'acquisto sono forniti in dotazione i seguenti articoli. Controllare tutto il contenuto e contattare il rivenditore autorizzato in caso di articoli mancanti o danneggiati.

- **CD-ROM**
Il CD-ROM contiene i file indicati di seguito.
 - Procedura guidata per il rilascio del codice di autenticazione
Seguire la procedura illustrata nella presente Guida all'installazione per aggiornare la macchina.
 - 30 schemi da ricamo
 - Guida ai ricami (versione PDF)



- Guida all'installazione (la presente guida)

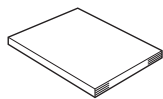

- **Set telaio per ricamo**
A 30 cm x L 20 cm (A 12 pollici x L 8 pollici)
Dopo aver attivato il KIT, è possibile utilizzare questo telaio per ricamo, ampliando l'area massima di ricamo rispetto ai telai precedentemente forniti in dotazione con la macchina. Questo telaio per ricamo consente di ricamare diversi disegni salvati sul CD-ROM in dotazione.

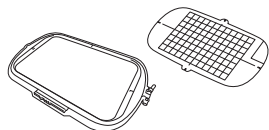

- **Set telaio per ricamo**
A 20 cm x L 20 cm (A 8 pollici x L 8 pollici)
Questo telaio per ricamo è perfetto per la trapuntatura



Utilizzo dei manuali

- **Guida all'installazione (il presente manuale)**
La presente guida comprende le descrizioni degli accessori e delle procedure per l'aggiornamento della macchina.
- **Manuale d'istruzione (versione PDF)**
Il Manuale d'istruzione descrive l'uso della macchina con le funzioni aggiunte e gli accessori.
Utilizzare la macchina e gli accessori forniti in dotazione come descritto nel Manuale d'istruzione.
Per visualizzare e stampare il Manuale d'istruzione è necessario Adobe Reader.





Nota

- Scaricare una copia del Manuale d'istruzione utilizzando la Procedura guidata per il rilascio del codice di autenticazione al passaggio 7 a pagina 5.

Panoramica dell'installazione

Innanzitutto, utilizzare la Procedura guidata per il rilascio del codice di autenticazione contenuta nel CD-ROM fornito in dotazione per ottenere il codice di autenticazione. Dopo di che, utilizzare il codice di ATTIVAZIONE nella schermata Impostazioni, pagina 4 o 7, per attivare l'applicazione di aggiornamento per il KIT I sulla macchina da cucire.

Nella sezione delle procedure,  indica le operazioni eseguite con la macchina da cucire e  indica le operazioni eseguite con il computer.



[Passaggio 1] Annotare il numero di identificazione interno della macchina (No.).



[Passaggio 2] Inserire il CD-ROM nell'unità CD-ROM del computer e avviare la Procedura guidata per il rilascio del codice di autenticazione.



[Passaggio 3] Seguire le istruzioni della procedura guidata per ottenere il codice di autenticazione.



[Passaggio 4] Installare l'applicazione di aggiornamento per il KIT I sulla macchina per cucire.



[Passaggio 5] Spegnerla macchina, rimuovere la periferica supporto USB e riaccendere la macchina.



[Passaggio 6] Dopo aver completato l'installazione dell'aggiornamento, autenticare il "KIT I" nella schermata Impostazioni della macchina per cucire.

Requisiti del computer

Prima di avviare la Procedura guidata per il rilascio del codice di autenticazione, verificare che il computer da collegare soddisfi le seguenti condizioni operative.

Computer	PC IBM o computer compatibile
Sistema operativo	Windows Vista, Windows 7, 8, 8.1 (32 o 64bit)
Unità CD-ROM	Necessaria per l'installazione
Altro	Disponibilità di una connessione Internet e di una porta USB libera (necessarie per l'aggiornamento della macchina per cucire) quando si utilizza il computer

* "IBM" è un marchio registrato di IBM Corporation negli Stati Uniti e in altri Paesi.

* "Windows" e "Windows Vista" sono marchi registrati di Microsoft Corporation negli Stati Uniti e in altri Paesi.

* "Adobe" e "Adobe Reader" sono marchi o marchi registrati di Adobe Systems Incorporated negli Stati Uniti e/o in altri paesi.

* Ciascuna delle aziende i cui software sono stati menzionati nella presente guida è in possesso di un contratto di licenza software specifico per i programmi brevettati.

Tutti gli altri marchi e prodotti menzionati nella presente guida sono marchi registrati delle rispettive società. Tuttavia, le spiegazioni di segni quali [®] e [™] non sono fornite chiaramente all'interno del testo.

Procedura d'installazione

La seguente procedura descrive come aggiornare la macchina per cucire al KIT I.

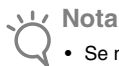

Nota

- Se non si completa fino alla fine la procedura descritta di seguito, la macchina per cucire non può essere aggiornata al KIT I.
- Per scaricare il programma di aggiornamento e ottenere un codice di autenticazione è necessario l'accesso a Internet.



- 1 Annotare il numero di 10 cifre (numero di identificazione interno della macchina) visualizzato accanto a "No." a pag. 4 o 7 della schermata Impostazioni.



Promemoria

- Assicurarsi che il numero di identificazione interno della macchina (No.) sia registrato in modo corretto in quanto queste cifre devono essere inserite nella Procedura guidata per il rilascio del codice di autenticazione in vista dell'ottenimento di tale codice.

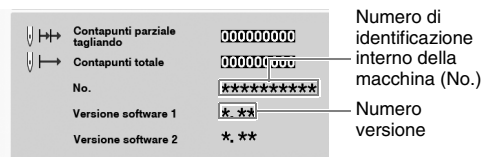

* Il numero di pagine nella schermata Impostazioni varia a seconda della versione.



Nota

- Il numero di identificazione interno della macchina visualizzato accanto a "No." è diverso dal numero di serie (N. SER.) riportato sull'etichetta applicata alla parte posteriore della macchina da cucire.



- 2 Inserire il CD-ROM nell'unità CD-ROM del computer.



Promemoria

- In Windows 7 o Windows Vista, quando viene visualizzata la finestra di dialogo **AutoPlay**, fare clic su **Apri cartella per visualizzare i file**.
- In Windows 8 o 8.1, fare clic sul messaggio **"Toccare per scegliere l'operazione per il disco"** che viene visualizzato nella schermata.



- 3 Aprire l'unità CD-ROM (di solito l'unità "D") sul **Computer (Risorse del computer)** e fare doppio clic su  per avviare la **Procedura guidata per il rilascio del codice di autenticazione**.



Promemoria

- Per avviare la Procedura guidata per il rilascio del codice di autenticazione è possibile utilizzare la seguente procedura.
 1. Fare clic su **Avvia (Start)**.
 2. Fare clic su **Esegui**, oppure digitare "esegui" nella casella di ricerca e fare clic su **Esegui** nell'elenco dei risultati.

→ Viene visualizzata la finestra di dialogo **Esegui**.

3. Digitare il percorso del file dell'applicazione (**D:\KeyWizard_KIT1.exe**) e fare clic su **OK**.

→ Viene visualizzata automaticamente la finestra di dialogo **Select Language (Seleziona lingua)**.



- 4 Selezionare la lingua desiderata e fare clic su **"OK"**.



→ Viene visualizzata la **Procedura per il rilascio del codice di autenticazione del KIT I**.



- 5 Leggere attentamente le informazioni visualizzate e fare clic su **"Avanti"**.

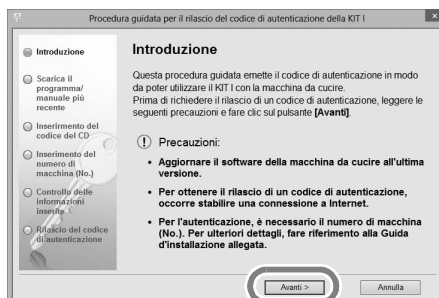



- 6** Scaricare il programma di aggiornamento più recente. Confermare il modello della macchina, fare clic su **“Download”**, quindi salvare il programma di aggiornamento (*****.upf) sul computer. Fare clic su **“Avanti”**.

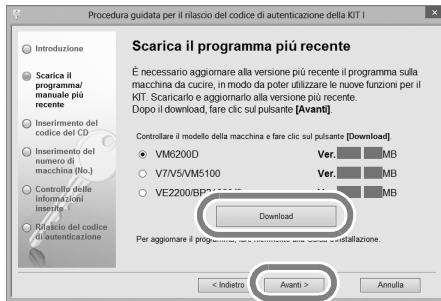

Fare clic su **“OK”** per chiudere il messaggio di seguito.

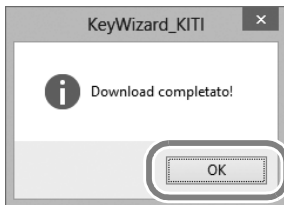

Nota

- Se la versione visualizzata o successiva è già stata installata sulla macchina (vedere il passaggio **1** a pag. 4), fare clic su **“Avanti”** per continuare la procedura senza scaricare il file più recente. Seguire i passaggi **8** e **12** e passare ai passaggi **13** e **18**, quindi iniziare la procedura dal passaggio **19** a pag. 9.



- 7** Scaricare il manuale. Selezionare la lingua desiderata e fare clic su **“Download”** per salvare il file sul computer, quindi fare clic su **“Avanti”**.

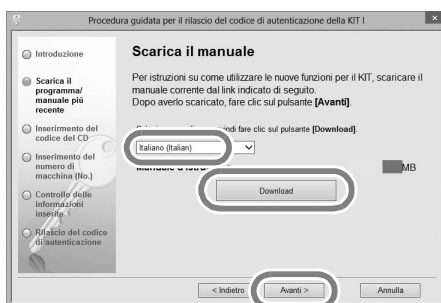

- 8** Digitare il codice del CD di 15 cifre indicato sull'etichetta apposta sulla custodia del CD-ROM del kit di aggiornamento e fare clic su **“Avanti”**.

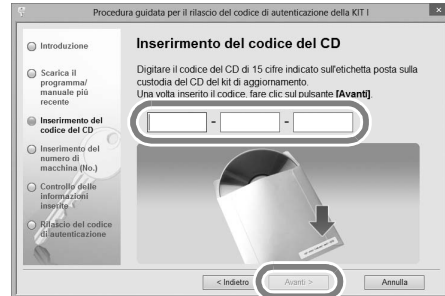

Nota

- Digitare il codice del CD indicato sull'etichetta apposta sulla custodia del CD-ROM per le macchine.

Se viene visualizzato un messaggio di errore

Controllare il seguente elenco relativo ai possibili errori di inserimento. Per chiudere il messaggio, fare clic su **“OK”**.

- Sono stati inseriti simboli o caratteri diversi da lettere e numeri?
- Il numero **“1”** e la lettera maiuscola **“I”** sono stati digitati correttamente?
- Il numero **“0”** e la lettera maiuscola **“O”** sono stati digitati correttamente?



Promemoria

- Le lettere maiuscole **“I”** e **“O”** non si utilizzano nel codice del CD. Inoltre, nel codice del CD non vengono utilizzati simboli.



- 9 Digitare il numero di identificazione interno della macchina (No.) annotato al passaggio 1 e fare clic su **“Avanti”**.



Se viene visualizzato un messaggio di errore

Controllare di aver inserito solo numeri e non simboli o caratteri diversi. Per chiudere il messaggio, fare clic su **“OK”**.



- 10 Controllare attentamente le informazioni inserite e fare clic su **“Autentica”**.

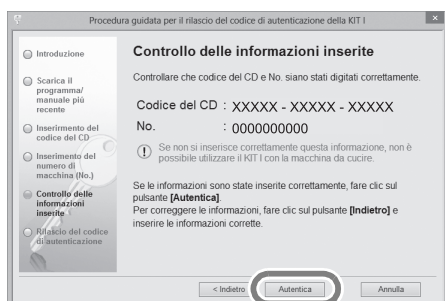

Promemoria

- Per modificare le informazioni inserite, fare clic su **“Indietro”**.

Se viene visualizzato un messaggio di errore

Controllare il seguente elenco relativo ai possibili errori. Per chiudere il messaggio, fare clic su **“OK”**.

- Controllare che codice del CD e numero di identificazione interno della macchina (No.) siano stati inseriti correttamente e ripetere la procedura dal passaggio 3.
- Il codice del CD è valido per l'utilizzo soltanto con uno specifico numero di identificazione interno della macchina (No.). Controllare che il codice del CD sia stato inserito correttamente e ripetere la procedura dal passaggio 3.
- Controllare la connessione Internet e fare nuovamente clic su **“Autentica”**.



- 11 Annotare il codice di autenticazione di 8 cifre visualizzato.



Nota

- Una volta completato l'aggiornamento della macchina per cucire al KIT I, occorre digitare il codice di autenticazione nella schermata Impostazioni della macchina da cucire.



- 12 Fare clic su **“Fine”**.

Il codice di autenticazione è stato correttamente ottenuto.

A questo punto procedere all'installazione dell'applicazione di aggiornamento per il KIT I sulla macchina per cucire.

Per installare l'applicazione di aggiornamento utilizzare un supporto USB o un computer.

Se si deve utilizzare un **supporto USB**, fare riferimento alle istruzioni che seguono.

Se si deve utilizzare un **computer**, fare riferimento alla procedura descritta a pag. 8.

Quando si utilizza un supporto USB per eseguire

l'installazione



- 13** Tenendo premuto il pulsante “Infilatura automatica”, accendere la macchina per cucire.



- 14** Copiare il programma di aggiornamento scaricato al passaggio **6** sul supporto USB.



Nota

- Copiare solo il programma di aggiornamento su un supporto USB vergine riformattato; sul supporto non deve trovarsi nessun altro file.



- 15** Premere  .

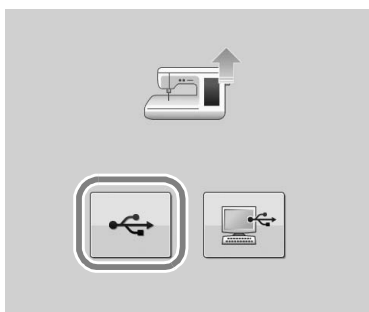

- 16** Inserire il supporto USB nel connettore della porta USB primaria (superiore) sul lato destro della macchina. Saranno necessari alcuni secondi perché la macchina riconosca l'inserimento del supporto USB nella porta.



- 17** Premere  .



Nota

Quando viene visualizzato il messaggio “**Aggiornamento terminato.**”, l'installazione dell'applicazione di aggiornamento è completata. (In caso di errore, viene visualizzato un messaggio scritto in rosso.)



- 18** Rimuovere il supporto USB.

Continuare con il passaggio **19** a pag. 9.

Quando si utilizza un computer per eseguire

l'installazione



- 13 Tenendo premuto il pulsante “Infilatura automatica”, accendere la macchina per cucire.



- 14 Premere .

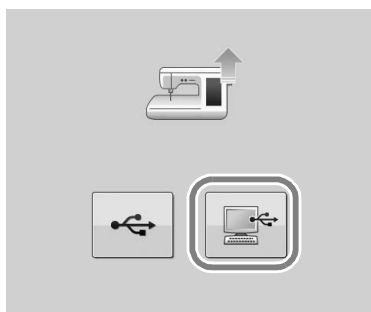

- 15 Inserire i connettori del cavo USB nei connettori delle porte USB corrispondenti sul computer e sulla macchina.

→ **Computer (Risorse del computer)** viene visualizzato **Disco rimovibile**.

Nota

- Non collegare altre periferiche supporto USB al computer quando si utilizza il cavo USB.



- 16 Copiare il programma di aggiornamento scaricato al passaggio 6 su **Disco rimovibile**.

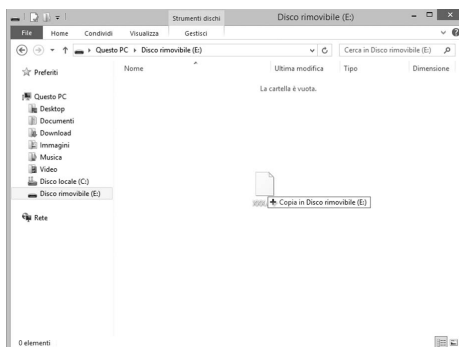

Nota

- Sul display LCD della macchina per cucire viene visualizzato il messaggio “**Connesso al PC. Non disconnettere il cavo USB**”.



- 17 Premere .



Nota

- Quando viene visualizzato il messaggio “**Aggiornamento terminato.**”, l'installazione dell'applicazione di aggiornamento è completata. (In caso di errore, viene visualizzato un messaggio scritto in rosso.)



18 Scollegare il cavo USB.



19 Spegner e riaccendere la macchina per cucire.

20 Visualizzare pagina 4 o 7 della schermata Impostazioni.



21 Premere **ATTIVAZIONE** nella schermata Impostazioni.

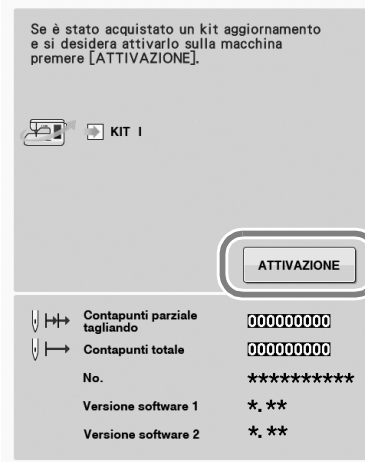

22 Premere **KIT 1** nella seguente schermata.



23 Digitare il codice di autenticazione di 8 cifre annotato al passaggio 11 e premere **IMPOSTA**.

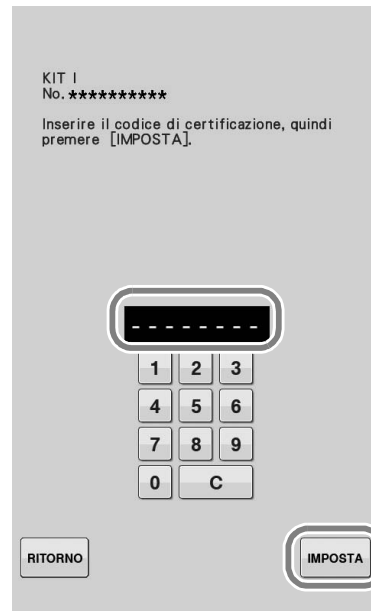



- 24** Quando compare la seguente schermata, l'autenticazione è completata. Spegnerne e riaccendere la macchina per cucire.

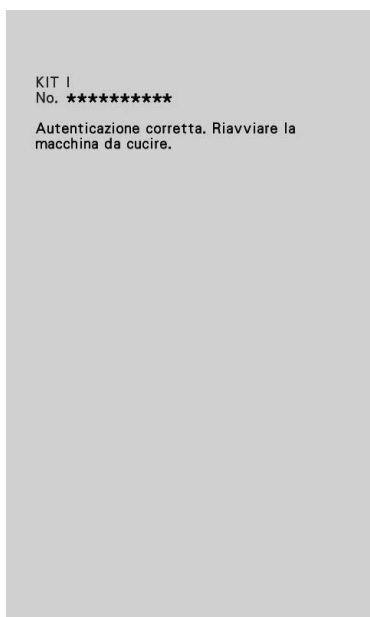

- 25** Assicurarsi che vi sia un segno di spunta accanto a "KIT I" nella schermata Impostazioni.

- Il "KIT I" è stato correttamente autenticato.

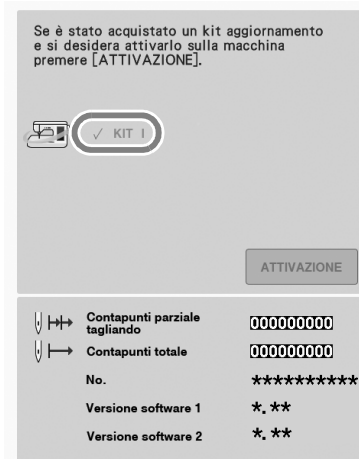

Nota

- Se viene visualizzata la seguente schermata, digitare il codice di autenticazione di 8 cifre annotato al passaggio **11** e premere **IMPOSTA**.



- In caso di smarrimento del codice di autenticazione, ripetere i passaggi da **2** a **12** per ottenere il codice di autenticazione.



Nota

- Per maggiori informazioni sulle funzioni aggiornate, vedere il Manuale d'istruzione (versione PDF) scaricato utilizzando la Procedura guidata per il rilascio del codice di autenticazione. Per informazioni sul download del Manuale d'istruzione, andare a pag. 5.

CONTENIDO

Accesorios.....	2
Utilizar los manuales.....	2
Introducción a la instalación	3
Requisitos del ordenador.....	3
Procedimiento de instalación	4

Accesorios

Los siguientes elementos están incluidos con la compra. Compruebe el contenido y si falta alguno de los elementos, o si alguno de ellos está dañado, póngase en contacto con su distribuidor autorizado.

- **CD-ROM**
El CD-ROM contiene los siguientes archivos.
 - El Asistente para la emisión de claves de certificaciones
Siga el procedimiento de esta Guía de instalación para actualizar la máquina.
 - 30 diseños de bordado
 - Guía de diseños de bordado (versión en PDF)



- Guía de instalación (esta guía)

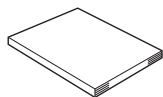

- **Conjunto del bastidor de bordado**
Alt. 30 cm x Anch. 20 cm (Alt. 12 pulgadas x Anch. 8 pulgadas)
Una vez activado el KIT ya podrá utilizarse este bastidor de bordado, y el área de bordado máxima será más amplia que con los demás bastidores incluidos con la máquina. Con este bastidor de bordado pueden bordarse varios patrones guardados en el CD-ROM incluido.

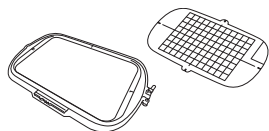

- **Conjunto del bastidor de bordado**
Alt. 20 cm x Anch. 20 cm (Alt. 8 pulgadas x Anch. 8 pulgadas)
Este bastidor de bordado es perfecto para acolchados.



Utilizar los manuales

- **Guía de instalación (este manual)**
Esta guía contiene descripciones de los accesorios y procedimientos para actualizar la máquina.
- **Manual de instrucciones (versión en PDF)**
El Manual de instrucciones facilita descripciones para utilizar la máquina con las funciones y accesorios añadidos.
Utilice siempre la máquina y los accesorios incluidos siguiendo las descripciones del Manual de instrucciones.
Para ver e imprimir el Manual de instrucciones es necesario utilizar Adobe Reader.





Nota

- Descargue una copia del Manual de instrucciones utilizando el Asistente para la emisión de claves de certificaciones en el paso 7 de la página 5.

Introducción a la instalación

En primer lugar, utilice el Asistente para la emisión de claves de certificaciones, que se encuentra en el CD-ROM incluido, para obtener una clave de certificaciones.

A continuación, utilice la clave CERTIFICACIÓN de la pantalla Ajustes, página 4 ó 7, para activar la aplicación de actualización para el KIT I en la máquina de coser.

En la sección de procedimientos,  indica las operaciones realizadas con la máquina de coser y  indica las operaciones realizadas con el ordenador.



[Paso 1] Anote el número de identificación interna de la máquina (No.).



[Paso 2] Inserte el CD-ROM en la unidad de CD-ROM del ordenador y, a continuación, inicie el Asistente para la emisión de claves de certificaciones.



[Paso 3] Siga las instrucciones del asistente para obtener la clave de certificaciones.



[Paso 4] Instale la aplicación de actualización para el KIT I en la máquina de coser.



[Paso 5] Desactive la máquina, retire el dispositivo USB y vuelva a activar la máquina.



[Paso 6] Una vez instalada correctamente la actualización, compruebe que aparece "KIT I" en la pantalla Ajustes de la máquina de coser.

Requisitos del ordenador

Antes de iniciar el Asistente para la emisión de claves de certificaciones, compruebe que el ordenador al que se va a conectar cumple las siguientes condiciones de funcionamiento.

Ordenador	PC IBM u ordenador compatible
Sistema operativo	Windows Vista, Windows 7, 8, 8.1 (32 ó 64 bits)
Unidad de CD-ROM	Necesaria para la instalación
Otros	Conexión a Internet disponible y un puerto USB libre (necesario para actualizar la máquina de coser) cuando utilice un ordenador

- * "IBM" es una marca comercial registrada de IBM Corporation en los Estados Unidos y otros países.
- * "Windows" y "Windows Vista" son marcas comerciales registradas de Microsoft Corporation en Estados Unidos y en otros países.
- * "Adobe" y "Adobe Reader" son marcas comerciales registradas o marcas comerciales de Adobe Systems Incorporated en Estados Unidos y/o en otros países.
- * Todas las empresas cuyo software se menciona en esta guía tienen un Acuerdo de Licencia de Software específico para sus programas patentados. El resto de marcas y nombres de productos mencionados en esta guía son marcas comerciales registradas de sus respectivas empresas. No obstante, las explicaciones para marcas tales como [®] y [™] no se detallan claramente en el texto.

Procedimiento de instalación

El siguiente procedimiento describe cómo actualizar la máquina de coser al KIT I.



Nota

- Si el procedimiento descrito a continuación no se realiza en su totalidad, la máquina de coser no se podrá actualizar al KIT I.
- Para descargar el programa de actualización y obtener una clave de certificaciones, es necesario disponer de acceso a Internet.



- 1 Anote el número de 10 dígitos (número de identificación interna de la máquina) que se muestra al lado de "No." en la página 4 ó 7 de la pantalla Ajustes.



Recuerde

- Compruebe que el número de identificación interna de la máquina (No.) quede registrado correctamente, ya que deberá introducir estos números en el Asistente para la emisión de claves de certificaciones con el fin de poder obtener dicha clave.

Recuento de uso	0000000000	Número de identificación interna de la máquina (No.)
Número total	0000000000	
No.	*****	Versión número
Versión de software 1	* **	
Versión de software 2	* **	

* El número de páginas de la pantalla Ajustes puede variar según la versión.



Nota

- El número de identificación interna de la máquina que aparece al lado de "No." es diferente del número de serie (Nº SER.) mostrado en la etiqueta pegada en la parte posterior de la máquina de coser.



- 2 Inserte el CD-ROM en la unidad de CD-ROM del ordenador.



Recuerde

- En Windows 7 o Windows Vista, cuando aparezca el cuadro de diálogo **Reproducción automática**, haga clic en **Abrir carpeta para ver archivos**.
- En Windows 8 u 8.1, haga clic en el mensaje **"Pulsa para seleccionar lo que le ocurre a este disco."** que aparece en pantalla.



- 3 Abra la unidad de CD-ROM designada (normalmente es la unidad "D") en el **Equipo (Mi PC)**, y haga doble clic en para iniciar el **Asistente para la emisión de claves de certificaciones**.



Recuerde

- El procedimiento siguiente se puede utilizar para iniciar el Asistente para la emisión de claves de certificaciones.
 1. Haga clic en **Inicio**.
 2. Haga clic en **Ejecutar**, o bien escriba ejecutar en el cuadro de búsqueda y, a continuación, en la lista de resultados, haga clic en **Ejecutar**.→ Aparecerá el cuadro de diálogo **Ejecutar**.
 3. Escriba la ruta del archivo de la aplicación (**D:\KeyWizard_KIT1.exe**), y haga clic en **OK**.

→ Aparece automáticamente el cuadro de diálogo **Select Language (Elegir idioma)**.



- 4 Seleccione el idioma deseado y, a continuación, haga clic en **"OK"**.

Select Language

- English
- Deutsch (German)
- Français (French)
- Nederlands (Dutch)
- Italiano (Italian)
- Español (Spanish)
- 中文 (Chinese)

Cancel OK

→ Aparece el **Asistente para la emisión de claves de certificaciones, KIT I**.



- 5 Lea atentamente la información que aparece y, a continuación, haga clic en **"Siguiente"**.

Asistente para la emisión de claves de certificaciones, KIT I

Introducción

Este asistente facilita la clave de certificación para que pueda utilizarse KIT I con la máquina de coser. Antes de solicitar que se emita una clave de certificaciones, lea las siguientes precauciones y, a continuación, haga clic en el botón **[Siguiente]**

Precauciones:

- Actualice el software de la máquina de coser a la última versión.
- Para que se pueda emitir una clave de certificaciones, se debe establecer una conexión a Internet.
- Para la certificación, es necesario el número de la máquina (No.). Para obtener más información, consulte la Guía de instalación.

Siguiente >> Cancelar



- 6** Descargue el programa de actualización más reciente. Confirme el modelo de su máquina, haga clic en **“Descargar”**, y guarde el programa de actualización (*.*****.upf) en su ordenador. Haga clic en **“Siguiente”**.

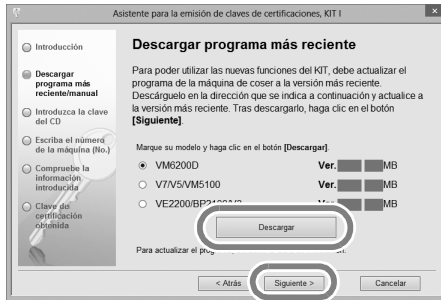

Haga clic en **“Aceptar”** para cerrar el mensaje.

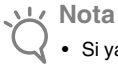

Nota

- Si ya está instalada en la máquina la versión que se muestra o una posterior (consulte el paso **1** en la página 4), haga clic en **“Siguiente”** para continuar con el procedimiento sin descargar el archivo más reciente. Siga los pasos **8** a **12** y omita los pasos **13** a **18**; a continuación, inicie el procedimiento desde el paso **19** en la página 9.



- 7** Descargue el manual. Seleccione su idioma preferido y haga clic en **“Descargar”** para guardar el archivo en su ordenador, y luego haga clic en **“Siguiente”**.

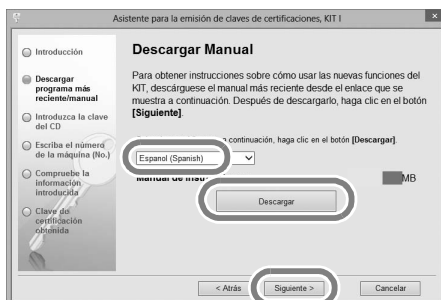

- 8** Escriba la clave del CD de 15 dígitos mostrada en la etiqueta pegada en el sobre del CD-ROM del kit de actualización y, a continuación, haga clic en **“Siguiente”**

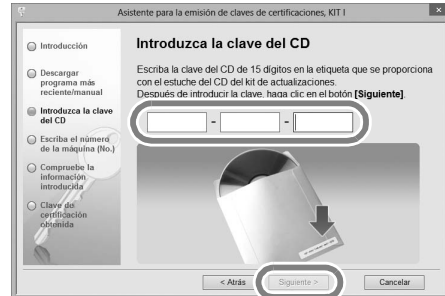

Nota

- Escriba la clave del CD mostrada en la etiqueta pegada en el sobre del CD-ROM para máquinas.

Si aparece un mensaje de error

Compruebe la lista siguiente para posibles errores en la entrada. Para cerrar el mensaje, haga clic en **“Aceptar”**.

- ¿Hay símbolos o caracteres introducidos que no son letras ni números?
- ¿Ha introducido la letra “l” mayúscula en vez del número “1”?
- ¿Ha introducido la letra “O” mayúscula en vez del número “0”?



Recuerde

- Las letras mayúsculas “O” e “l” no se utilizan en la clave del CD. Tampoco se utilizan símbolos en la clave del CD.



- 9 Escriba el número de identificación interna de la máquina (No.) que ha anotado en el paso 1 y, a continuación, haga clic en “**Siguiente**”.

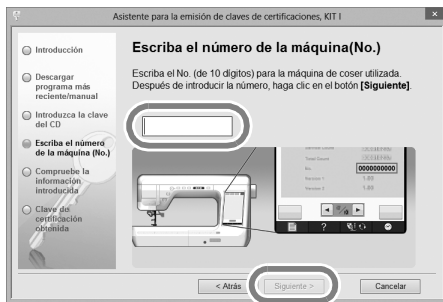

Si aparece un mensaje de error

Compruebe que no haya introducido símbolos ni caracteres distintos a números. Para cerrar el mensaje, haga clic en “**Aceptar**”.



- 10 Compruebe minuciosamente que la información ha sido introducida correctamente y luego haga clic en “**Certificar**”.

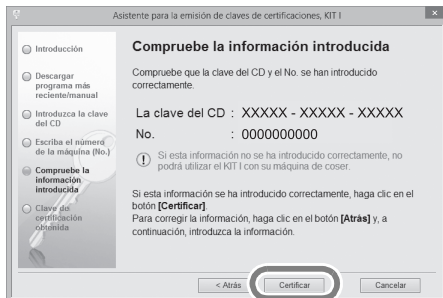

Recuerde

- Para cambiar la información introducida, haga clic en “**Atrás**”.

Si aparece un mensaje de error

Compruebe la lista siguiente para posibles errores. Para cerrar el mensaje, haga clic en “**Aceptar**”.

- Compruebe que la clave del CD y el número de identificación interna de la máquina (No.) hayan sido introducidos correctamente y, a continuación, repita el procedimiento desde el paso 3.
- La clave del CD solo es válida para utilizarse con un número de identificación interna de la máquina específico (No.). Compruebe que la clave del CD se ha introducido correctamente y, a continuación, repita el procedimiento desde el paso 3.
- Compruebe la conexión a Internet y, a continuación, vuelva a hacer clic en “**Certificar**”.



- 11 Anote la clave de certificaciones de 8 dígitos que aparece.



Nota

- Después de actualizar la máquina de coser al KIT I, debe introducir la clave de certificaciones en la pantalla Ajustes de la máquina de coser.



- 12 Haga clic en “**Finalizar**”.

La clave de certificaciones se ha obtenido correctamente.

Ahora puede instalar la aplicación de actualización para el KIT I en la máquina de coser.

Utilice un dispositivo USB o un ordenador para instalar la aplicación de actualización.

Si va a utilizar un **dispositivo USB**, consulte las instrucciones siguientes.

Si va a utilizar un **ordenador**, consulte el procedimiento descrito en la página 8.

Si utiliza un dispositivo USB para realizar la instalación



- 13** Active la máquina de coser manteniendo pulsado el botón de “enhebrado automático”.



- 14** Copie el programa de actualización descargado en el paso **6** en el dispositivo USB.



Nota

- Copie solo el programa de actualización en un dispositivo USB vacío y reformateado; no debe contener ningún otro archivo.



- 15** Pulse .

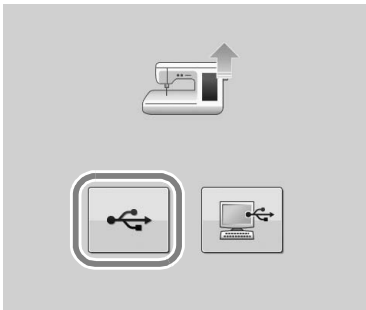

- 16** Inserte el dispositivo USB en el conector del puerto USB principal (superior) del lado derecho de la máquina. La máquina tardará unos segundos en detectar que se ha insertado un dispositivo USB en el puerto.



- 17** Pulse .

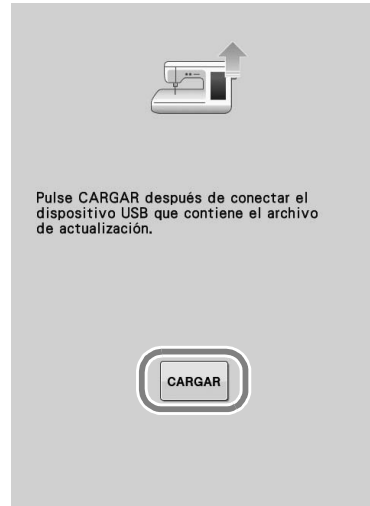

Nota

Cuando aparezca el mensaje “**Actualización terminada.**”, la instalación de la aplicación de actualización se habrá completado. (Si se produce un error, aparecerá un mensaje en rojo).



- 18** Extraiga el dispositivo USB.

Continúe con el paso **19** en la página 9.

Si utiliza un ordenador para realizar la instalación



- 13 Active la máquina de coser manteniendo pulsado el botón de “enhebrado automático”.



- 14 Pulse

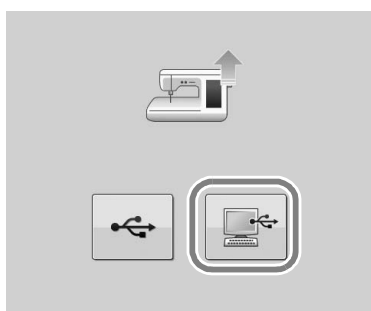

- 15 Conecte el cable USB a los correspondientes conectores USB del ordenador y de la máquina.

→ Aparece **Disco extraíble** en **Equipo (Mi PC)**.



Nota

- No conecte otros dispositivos USB multimedia en el ordenador cuando utilice el cable USB.



- 16 Copie el programa de actualización descargado en el paso 6 en el **Disco extraíble**.

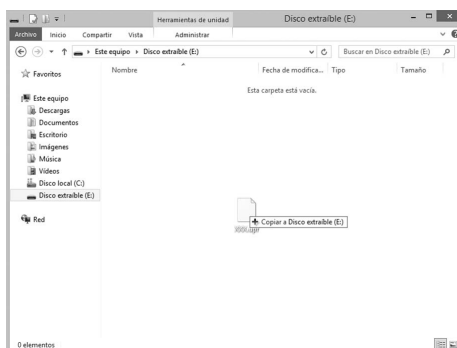

Nota

- Aparece en la pantalla LCD de la máquina de coser el mensaje “**Conectado al PC. No desconecte el cable USB**”.



- 17 Pulse **CARGAR**.



Nota

- Cuando aparezca el mensaje “**Actualización terminada.**”, la instalación de la aplicación de actualización se habrá completado. (Si se produce un error, aparecerá un mensaje en rojo).



18 Desconecte el cable USB.



19 Apague la máquina de coser y, a continuación, enciéndela de nuevo.

20 Visualice la página 4 ó 7 de la pantalla Ajustes.



21 Pulse **CERTIFIC.** en la pantalla Ajustes.

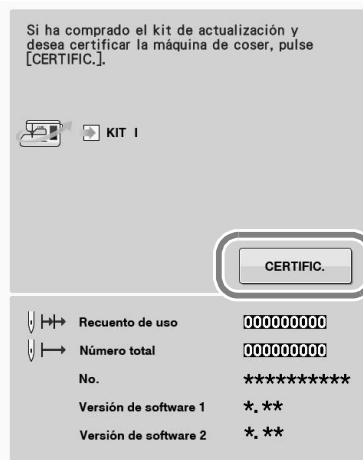

22 Pulse **KIT I** en la pantalla siguiente.



23 Escriba la Clave de Certificaciones de 8 dígitos anotada en el paso 11 y, a continuación, pulse

CON-FIGURAR

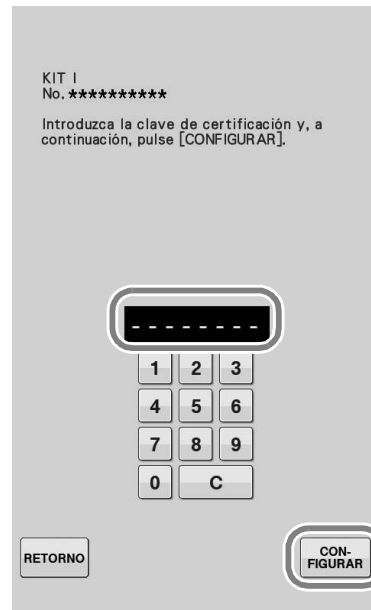



- 24** La certificación se habrá completado cuando aparezca la siguiente pantalla. Desactive la máquina de coser y actívela de nuevo.

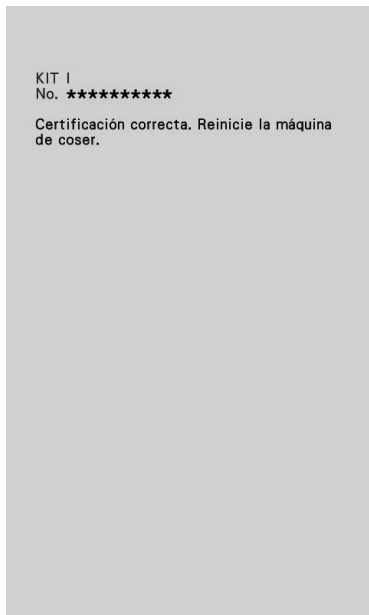

- 25** Compruebe que haya aparecido una marca de verificación junto a "KIT I" en la pantalla Ajustes.

- "KIT I" ha sido certificada correctamente.



Nota

- Si aparece la siguiente pantalla, escriba la Clave de Certificaciones de 8 dígitos anotada en el paso **11** y, a continuación, pulse **CON-FIGURAR**.

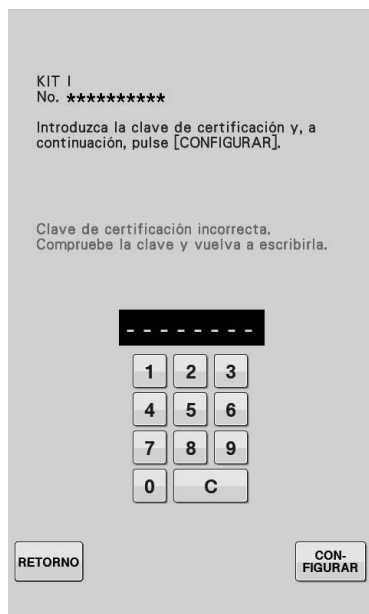

- Si se ha perdido la clave de certificaciones, repita los pasos del **2** al **12** para obtenerla.



Nota

- Para más detalles acerca de las funciones actualizadas, consulte el Manual de instrucciones (versión en PDF) que ha descargado utilizando el Asistente para la emisión de claves de certificaciones. Consulte, en la página 5, la información para descargar el Manual de instrucciones.

ÍNDICE

Acessórios	2
Como usar os manuais	2
Visão geral da instalação	3
Requisitos do computador	3
Procedimentos de instalação	4

Acessórios

Os itens a seguir estão inclusos na sua compra. Verifique todos os conteúdos e se algo estiver faltando ou danificado, contate o seu revendedor autorizado.

- **CD-ROM**
O CD-ROM contém os seguintes arquivos.
 - O assistente de emissão de chave de certificação
Siga o procedimento deste Guia de Instalação para atualizar sua máquina.
 - 30 desenhos de bordados
 - Guia de desenho de bordado (versão PDF)



- Guia de Instalação (este guia)

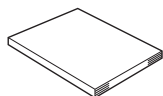

- **Conjunto de bastidor de bordar**
A 30 cm x L 20 cm (A 12 polegadas x L 8 polegadas)
Após o KIT ter sido ativado, este bastidor de bordar pode ser usado e a área máxima do bordado se torna mais ampla do que nos bastidores anteriores inclusos em sua máquina. Vários desenhos gravados no CD-ROM incluso podem ser bordados usando este bastidor de bordar.

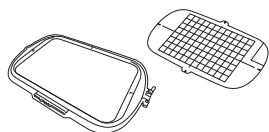

- **Conjunto de bastidor de bordar**
A 20 cm x L 20 cm (A 8 polegadas x L 8 polegadas)
Este bastidor de bordar é perfeito para acolchoados.



Como usar os manuais

- **Guia de Instalação (este manual)**
Este guia contém descrições dos acessórios e procedimentos para atualizar a máquina.
- **Manual de Operações (versão PDF)**
O Manual de Operações fornece descrições para usar a máquina com as funções e acessórios adicionados.
Certifique-se de usar a máquina e os acessórios inclusos de acordo com as descrições no Manual de Operações.
É necessário utilizar o Adobe Reader para visualizar e imprimir o Manual de Operações.





Nota

- Baixe uma cópia do Manual de Operações utilizando o assistente de emissão de chave de certificação no passo 7 da página 5.

Visão geral da instalação

Primeiramente, use o assistente de emissão de chave de certificação no CD-ROM anexo para obter uma chave de certificação. Em seguida, use a chave de CERTIFICAÇÃO na tela de configurações, página 4 ou 7, para ativar o aplicativo de atualização para o KIT I na máquina de costura.

Na seção de procedimentos,  indica as operações realizadas com a máquina de costura e  indica as operações realizadas com o computador.



[Passo 1] Anote o número de identificação interno da máquina (No.).



[Passo 2] Insira o CD-ROM na unidade de CD-ROM do computador e, em seguida, inicie o assistente de emissão de chave de certificação.



[Passo 3] Siga as instruções do assistente para obter a chave de certificação.



[Passo 4] Instale o aplicativo de atualização para o KIT I na máquina de costura.



[Passo 5] Desligue a máquina, retire o dispositivo de mídia USB e, em seguida, ligue a máquina novamente.



[Passo 6] Após a atualização ter sido instalada com sucesso, certifique o "KIT I" na tela de configurações da máquina de costura.

Requisitos do computador

Antes de iniciar o assistente de emissão de chave de certificação, verifique se o computador a ser conectado atende às seguintes condições de funcionamento.

Computador	PC IBM ou computador compatível
Sistema operacional	Windows Vista, Windows 7, 8, 8.1 (32 ou 64 bits)
Unidade de CD-ROM	Necessário para instalação
Outros	Conexão à Internet disponível e uma porta USB disponível (necessária para atualizar a máquina de costura) ao usar o computador

* "IBM" é uma marca registrada da IBM Corporation nos Estados Unidos e em outros países.

* "Windows" e "Windows Vista" são marcas registradas da Microsoft Corporation nos Estados Unidos e em outros países.

* "Adobe" e "Adobe Reader" são marcas registradas ou marcas comerciais da Adobe Systems Incorporated nos Estados Unidos e/ou em outros países.

* Cada empresa cujo título de software é mencionado neste guia tem um contrato de licença de software específico para os programas de sua propriedade.

Todas as outras marcas e nomes de produtos mencionados neste guia são marcas registradas de suas respectivas empresas. No entanto, as explicações para as marcações como ® e ™ não são claramente expostas no texto.

Procedimentos de instalação

O procedimento a seguir descreve como atualizar sua máquina de costura para o KIT I.

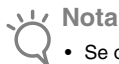

Nota

- Se o procedimento descrito a seguir não estiver totalmente concluído, a sua máquina de costura não poderá ser atualizada para o KIT I.
- O acesso à Internet é necessário para que se possa fazer o download do programa de atualização e para obter uma chave de certificação.



- 1 Anote um número de 10 dígitos (número de identificação interno da máquina) exibido ao lado do "No." na página 4 ou 7 da tela de configurações.



Lembrete

- Certifique-se de que o número de identificação interno da máquina (No.) é registrado com precisão, uma vez que esses números precisam ser digitados no assistente de emissão de chave de certificação para que esta seja obtida.

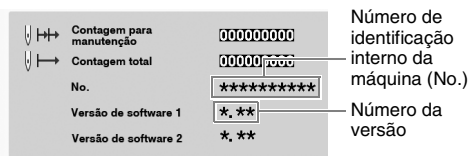

* O número de páginas na tela de configurações pode variar dependendo da versão.



Nota

- O número interno de identificação da máquina que aparece ao lado de "No." é diferente do número de série da máquina (SER. NO.) localizado na etiqueta fixada na parte traseira da máquina de costura.



- 2 Insira o CD-ROM na unidade de CD-ROM do computador.



Lembrete

- No Windows 7 ou Windows Vista, quando a caixa de diálogo **Reprodução Automática** é exibida, clique em **Abrir pasta para exibir arquivos**.
- No Windows 8 ou 8.1, clique na mensagem **Clique aqui para escolher o que acontece com este disco**, que aparece na tela.



- 3 Abra a unidade designada para o seu CD-ROM (geralmente a unidade "D:") em **Computador (Meu Computador)**, dê um clique duplo em para iniciar o **Certification Key Issuing Wizard (assistente de emissão de chave de certificação)**.



Lembrete

- O procedimento a seguir pode ser utilizado para iniciar o assistente de emissão de chave de certificação.
 1. Clique em **Iniciar**.
 2. Clique em **Executar** ou, na caixa de busca, digite executar e, em seguida, na lista de resultados, clique em **Executar**.→ A caixa de diálogo **Executar** é exibida.
 3. Digite o caminho para o arquivo do aplicativo (**D:\KeyWizard_KIT1.exe**) e, em seguida, clique em **OK**.

→ A caixa de diálogo **Select Language (Selecionar idioma)** é exibida automaticamente.



- 4 Selecione o idioma desejado e, em seguida, clicar em "OK".



→ **KIT I Certification Key Issuing Wizard (assistente de emissão de chave de certificação do KIT I)** é exibido.



- 5 Leia com atenção as informações exibidas e, em seguida, clique em "Next" (Próximo).

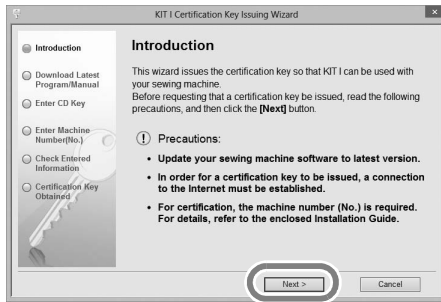

- 6 Baixe o programa de atualização mais recente. Confirme o modelo da sua máquina, clique em "Download" (Baixar) e, em seguida, salve o programa de atualização (*.upf) no seu computador. Clique em "Next" (Próximo).

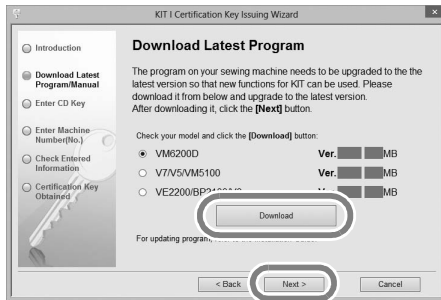

Clique em "OK" para fechar a mensagem abaixo.

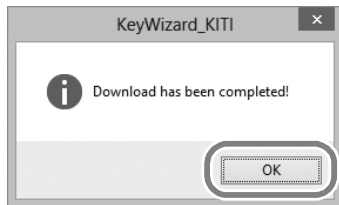

Nota

- Se a versão apresentada já tiver sido instalada na máquina (veja passo 1 na página 4), clique em "Next" (Próximo), para continuar com o procedimento sem baixar o arquivo mais recente. Siga os passos 8 a 12, e ignore os passos 13 a 18 e, em seguida, inicie o procedimento a partir do passo 19 na página 9.



- 7 Baixe o manual. Selecione seu idioma preferido e clique em "Download" (Baixar) para salvar o arquivo em seu computador e, em seguida, clique em "Next" (Próximo).

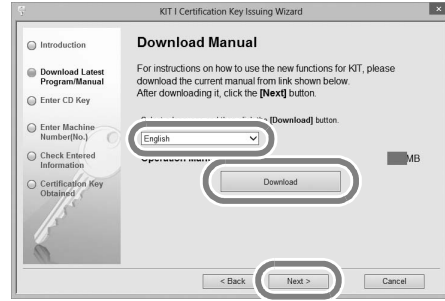

- 8 Digite a chave de CD de 15 dígitos localizada na etiqueta afixada ao envelope do CD-ROM do kit de atualização e clique em "Next" (Próximo).

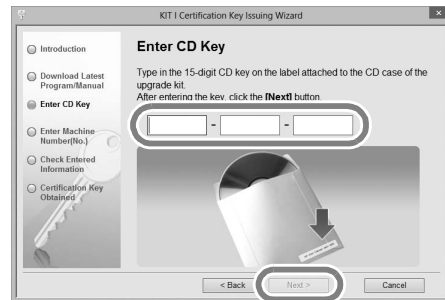

Nota

- Digite a chave de CD que se encontra na etiqueta afixada ao envelope do CD-ROM para máquinas.

Se uma mensagem de erro for exibida

Confira abaixo a lista de possíveis erros de entrada. Para fechar a mensagem, clique em "OK".

- Os símbolos ou caracteres que não sejam letras e números foram digitados?
- A letra maiúscula "I" foi digitada no lugar do número "1"?
- A letra maiúscula "O" foi digitada no lugar do número "0"?



Lembrete

- As letras maiúsculas "O" e "I" não são usadas na chave de CD. Além disso, nenhum símbolo é usado na chave do CD.



- 9 Digite o número de identificação interno da máquina (No.) escrito no passo 1 e, em seguida, clique em "Next" (Próximo).

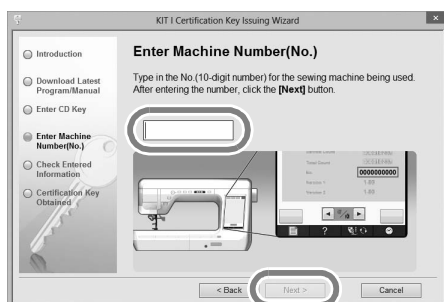

Se uma mensagem de erro for exibida

Verifique se símbolos ou caracteres diferentes de números foram digitados. Para fechar a mensagem, clique em "OK".



- 10 Verifique cuidadosamente se a informação foi digitada corretamente e clique em "Certify" (Certificar).

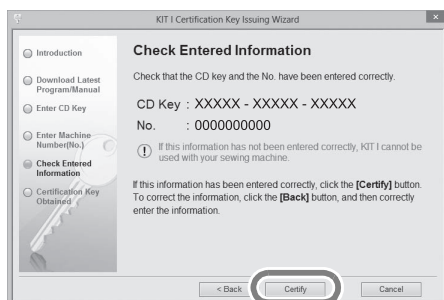

Lembrete

- Para alterar a informação digitada, clique em "Back" (Retornar).

Se uma mensagem de erro for exibida

Confira abaixo os possíveis erros de entrada. Para fechar a mensagem, clique em "OK".

- Verifique se a chave do CD e o número de identificação interno da máquina (No.) foram digitados corretamente e repita o procedimento desde o passo 3.
- A chave do CD é válida para utilização com apenas um número de identificação interno da máquina (No.). Verifique se a chave do CD foi digitada corretamente e repita o procedimento a partir do passo 3.
- Verifique a conexão de Internet e, em seguida, clique novamente em "Certify" (Certificar).



- 11 Anote a chave de certificação de 8 dígitos que é exibida.



Nota

- Após atualizar a máquina de costura para o KIT I, a chave de certificação deve ser digitada na tela de configurações da máquina de costura.



- 12 Clique em "Finish" (Finalizar).

A chave de certificação foi obtida com sucesso.

Agora prossiga para a instalação do aplicativo de atualização para KIT I na máquina de costura.

Use a mídia USB ou um computador para instalar o aplicativo de atualização.

Se a mídia USB é para ser usada, consulte as instruções a seguir.

Se um computador é para ser usado, consulte o procedimento descrito na página 8.

Ao usar mídia USB para executar a instalação



- 13 Enquanto pressiona o botão de "enchimento automático", ligue a máquina de costura.



- 14 Copie o programa de atualização baixado no passo 6 para a mídia USB.



Nota

- Copie o programa de atualização somente para uma mídia USB limpa reformatada; nenhum outro arquivo deve estar nesta mídia.



- 15 Pressione .

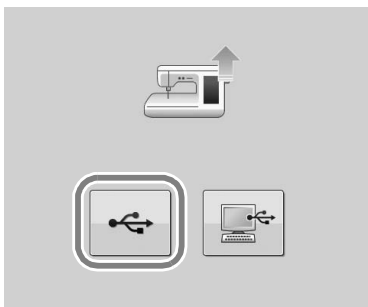

- 16 Insira a mídia USB no conector da porta USB principal (topo) no lado direito da máquina. É preciso alguns segundos até que a máquina reconheça que a mídia USB foi inserida na porta.



- 17 Pressione .

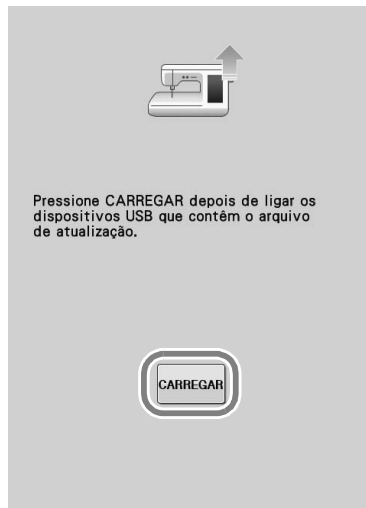

Nota

- Quando a mensagem "**Atualização completada.**" for exibida, a instalação do aplicativo atualizado foi concluída. (Se ocorrer um erro, uma mensagem aparecerá em vermelho.)



- 18 Remova a mídia USB.

Continue com o passo 19 na página 9.

Ao usar um computador para realizar a instalação



- 13 Enquanto pressiona o botão de "enchimento automático", ligue a máquina de costura.



- 14 Pressione .

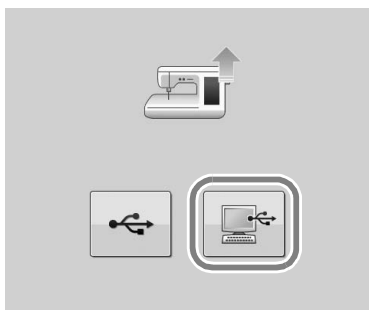

- 15 Conecte os conectores do cabo USB aos conectores da porta USB correspondente para o computador e à porta USB da máquina.

→ **Disco Removível** é exibido no **Computador (Meu Computador)**.



Nota

- Ao usar o cabo USB, não conecte nenhum dispositivo de mídia USB adicional ao computador.



- 16 Copie o programa de atualização baixado no passo 6 para o **Disco Removível**.

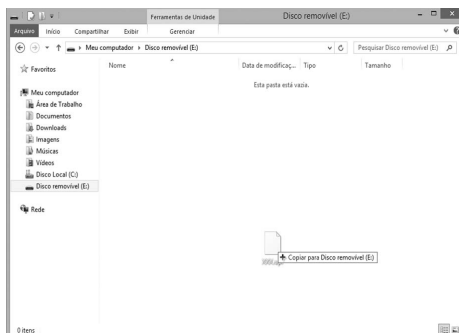

Nota

- A mensagem "**Conectado ao PC. Não desligue o cabo USB.**" é exibida na tela LCD da máquina de costura.



- 17 Pressione .



Nota

- Quando a mensagem "**Atualização completada.**" for exibida, a instalação do aplicativo atualizado foi concluída. (Se ocorrer um erro, uma mensagem aparecerá em vermelho.)



18 Desconecte o cabo USB.



19 Desligue a máquina de costura e, em seguida, ligue-a novamente.

20 Exiba a página 4 ou 7 da tela de configurações.



21 Pressione **CERTIFIC.** na tela de configurações.



22 Pressione **KIT 1** na tela a seguir.

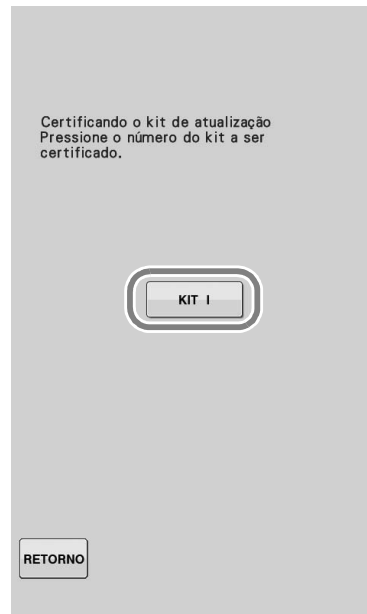

23 Digite a chave de certificação de 8 dígitos escrita no passo 11 e, em seguida, pressione

DEFINIR.





- 24** A certificação estará concluída quando a seguinte tela for exibida. Desligue a máquina de costura e ligue-a novamente.

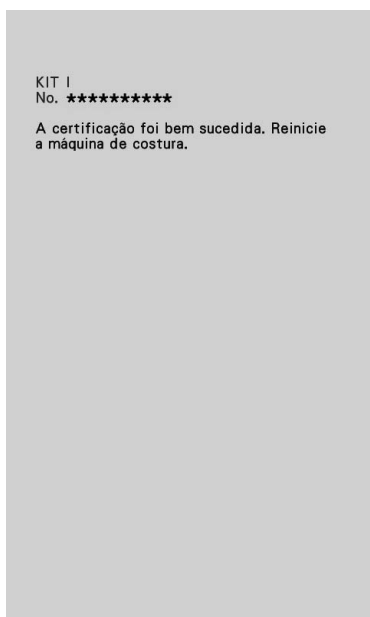

- 25** Confirme se existe uma marca de seleção ao lado do "KIT I" na tela de configurações.
- O "KIT I" foi certificado com sucesso.



Nota

- Se a tela a seguir for exibida, digite a chave de certificação de 8 dígitos escrita no passo **11** e, em seguida, pressione **DEFINIR**.

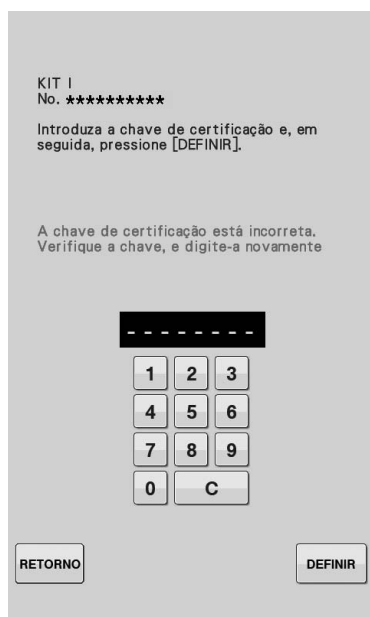

- Caso a chave de certificação seja perdida, repita os passos de **2** a **12** para obter a chave de certificação.



Nota

- Para mais detalhes sobre as funções atualizadas, consulte o Manual de Operações (versão PDF) baixado usando o assistente de emissão de chave de certificação.

Consulte a página 5 para informações sobre como baixar o Manual de Operações.

СОДЕРЖАНИЕ

Принадлежности	2
Использование руководств	2
Обзор процедуры установки	3
Системные требования	3
Процедура установки.....	4

Принадлежности

В данный комплект входят перечисленные ниже позиции. Внимательно проверьте содержимое комплекта. Если какие-либо позиции отсутствуют или повреждены, обратитесь к официальному дилеру.

- Компакт-диск
На компакт-диске записаны следующие файлы.
 - Мастер создания ключей сертификации
Чтобы установить обновление для машины, следуйте инструкциям, изложенным в данном Руководстве по установке.
 - 30 дизайнов вышивания
 - Руководство по дизайнам для вышивания (в формате PDF)



- Руководство по установке (данное руководство)

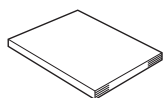

- Комплект пялец
Размер 30 × 20 см (В × Ш)
Эти пяльцы можно использовать после активации комплекта; при этом максимальная область вышивания становится шире, чем при использовании пялец, прилагающихся к вашей машине. При помощи этих пялец можно вышить несколько рисунков, записанных на прилагаемом компакт-диске.

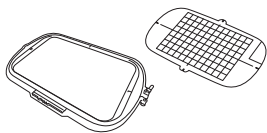

- Комплект пялец
Размер 20 × 20 см (В × Ш)
Эти пяльцы идеально подходят для квилтинга.



Использование руководств

- **Руководство по установке (данное руководство)**
В данном руководстве содержатся описания принадлежностей и порядок действий, которые необходимо выполнить для обновления машины.
- **Руководство пользователя (в формате PDF)**
В Руководстве пользователя приведены инструкции по использованию машины, оснащенной дополнительными функциями и принадлежностями.
При использовании машины и прилагаемых принадлежностей внимательно следуйте указаниям, изложенным в Руководстве пользователя.
Для просмотра и печати Руководства пользователя потребуется программа Adobe Reader.



Примечание

- Загрузите экземпляр Руководства пользователя с помощью Мастера создания ключей сертификации (Certification Key Issuing Wizard) - шаг 7 на странице 5.

Обзор процедуры установки

В первую очередь создайте ключ сертификации с помощью Мастера создания ключей сертификации (эта программа хранится на входящем в комплект компакт-диске). Затем введите ключ

СЕРТИФИКАЦИИ на экране настроек (страница 4 или 7), чтобы активировать программу обновления для Комплекта I на швейной машине.

В разделе процедуры  показывает операции, выполненные машиной, а  показывает операции, выполненные компьютером.



[Шаг 1] Запишите внутренний идентификационный номер машины (No.).



[Шаг 2] Вставьте прилагаемый компакт-диск в дисковод компьютера и запустите Мастер создания ключей сертификации (Certification Key Issuing Wizard).



[Шаг 3] Чтобы получить ключ сертификации, следуйте инструкциям Мастера создания ключей сертификации.



[Шаг 4] Установите программу обновления для Комплекта I на швейную машину.



[Шаг 5] Отключите машину, извлеките USB-устройство, а затем снова включите машину.



[Шаг 6] После завершения установки обновления, произведите сертификацию "Комплекта I" в настройках швейной машины (экран настроек).

Системные требования

Прежде чем запускать Мастер создания ключей сертификации, убедитесь, что подключаемый компьютер отвечает следующим параметрам.

Компьютер	Персональный компьютер IBM или совместимый компьютер
Операционная система	Windows Vista, Windows 7, 8, 8.1 (32-разрядная или 64-разрядная версия)
Дисковод для компакт-дисков	Требуется для установки
Прочее	В случае использования компьютера необходимо действующее подключение к Интернету и один свободный USB-порт (требуется для установки обновлений для швейной машины)

- * "IBM" является зарегистрированным товарным знаком Корпорации IBM, действующей в Соединенных штатах и других странах.
- * "Windows" и "Windows Vista" являются зарегистрированными товарными знаками корпорации Microsoft Corporation в США и других странах.
- * "Adobe" и "Adobe Reader" являются зарегистрированными товарными знаками или товарными знаками компании Adobe Systems Incorporated в США и/или других странах.
- * Каждая компания, название программного продукта которой упоминается в настоящем руководстве, имеет лицензионное соглашение по программному обеспечению, специфическое для своих запатентованных программ. Все прочие товарные знаки и названия продуктов, упоминаемые в настоящем руководстве, являются зарегистрированными товарными знаками соответствующих компаний. Однако в тексте данного руководства не проводится четкого различия между знаками ® и ™.

Процедура установки

Ниже описан порядок обновления швейной машины путем установки Комплекта I.



Примечание

- Обновление системы швейной машины путем установки Комплекта I будет успешно произведено только при условии последовательного и строгого выполнения всех изложенных ниже инструкций.
- Чтобы загрузить программу обновления и получить ключ сертификации, необходим доступ в Интернет.



- 1 Запишите 10-значный номер (внутренний идентификационный номер машины), который отображается в поле "No." на странице 4 или 7 экрана настроек.



Напоминание

- Проверьте, что внутренний идентификационный номер машины (No.) записан правильно, поскольку этот номер необходимо ввести на экране программы Certification Key Issuing Wizard (Мастер создания ключей сертификации) для получения ключа сертификации.



* Номера страниц экрана настроек могут отличаться в зависимости от версии.



Примечание

- Внутренний идентификационный номер машины, отображаемый в поле "No.", не является серийным номером машины (SER. NO.), обозначенным на табличке на задней панели швейной машины.



- 2 Вставьте прилагаемый компакт-диск в дисковод компьютера.



Напоминание

- Если используется операционная система Windows 7 или Windows Vista, при появлении диалогового окна AutoPlay нажмите **Open folder to view files** (Открыть папку для просмотра файлов).
- В Windows 8 или 8.1 нажмите на сообщение "Выберите, что требуется сделать с этим диском", которое появляется на экране.



- 3 В папке **Компьютер (Мой компьютер)** откройте диск, соответствующий компакт-дису (обычно это диск "D"), двойным щелчком по значку , чтобы запустить **Certification Key Issuing Wizard (Мастер создания ключей сертификации)**.



Напоминание

- Запустить Мастер создания ключей сертификации можно следующим образом.

1. Нажмите **Start (Пуск)**.
 2. Нажмите **Run (Выполнить)**, либо наберите команду "run" в окне поиска, затем нажмите **Run (Выполнить)** в появившемся списке результатов.
- Откроется диалоговое окно **Run (Выполнить)**.
3. Укажите путь к программному файлу (**D:\KeyWizard_KIT1.exe**), и затем нажмите **OK**.

→ Автоматически откроется диалоговое окно **Select Language (Выбор языка)**.



- 4 Выберите нужный язык, затем нажмите кнопку "OK".



→ Откроется **KIT I Certification Key Issuing Wizard (Мастер создания ключей сертификации для Комплекта I)**.



- 5 Внимательно прочтите появившуюся информацию, а затем нажмите кнопку "Next" (Далее).

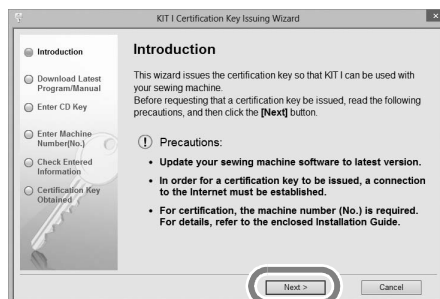



- 6** Загрузите последнее обновление программы. Выберите модель своей машины и нажмите кнопку **"Download"** (Загрузка), затем сохраните программу обновления (*****.urp) на своем компьютере. Нажмите кнопку **"Next"** (Далее).

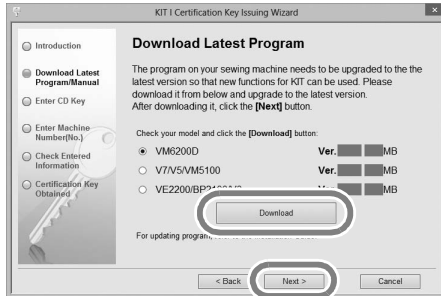

Чтобы закрыть появившееся ниже сообщение, нажмите кнопку **"OK"**.

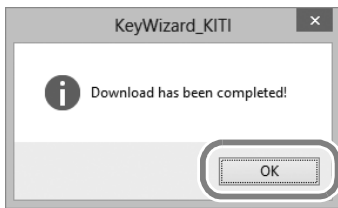

Примечание

- Если на машине уже установлена отображаемая версия или более поздняя версия программы (см. пункт **1**, на с. 4), нажмите кнопку **"Next"** (Далее), чтобы продолжить операцию без загрузки последней версии. Выполните пункты с **8** по **12** и, пропустив пункты с **13** по **18**, начните процедуру с пункта **19** на с. 9.



- 7** Загрузите руководство. Выберите нужный язык и нажмите кнопку **"Download"** (Загрузка), чтобы сохранить файл на своем компьютере, затем нажмите кнопку **"Next"** (Далее).



- 8** Введите 15-значный ключ компакт-диска, который указан на наклейке на конверте компакт-диска, входящего в комплект обновления, и затем нажмите кнопку **"Next"** (Далее)

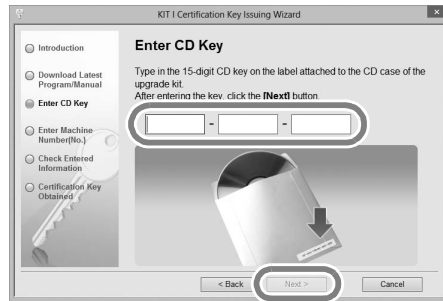

Примечание

- Введите ключ компакт-диска, напечатанный на наклейке на конверте компакт-диска комплекта обновления (для машин).

Если появится сообщение об ошибке

По приведенному ниже списку проверьте, что по вводу не сделано ошибок. Чтобы закрыть сообщение, нажмите кнопку **"OK"**.

- Не введены ли вами какие-либо другие знаки, кроме букв и цифр?
- Не введена ли заглавная буква "I" вместо цифры "1"?
- Не введена ли заглавная буква "O" вместо цифры "0"?



Напоминание

- Заглавные буквы "O" и "I" не используются в ключе компакт-диска. Кроме того, в ключе компакт-диска не используются никакие специальные символы.



- 9 Введите внутренний идентификационный номер машины (No.), который был записан ранее при выполнении пункта 1, и нажмите кнопку "Next" (Далее).

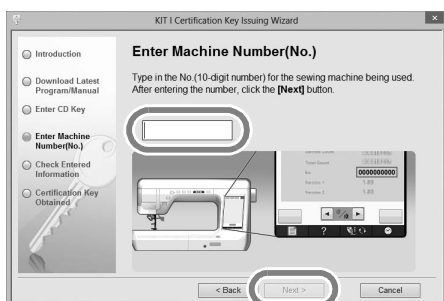

Если появится сообщение об ошибке

Проверьте, что не вводились никакие другие символы, кроме цифр. Чтобы закрыть сообщение, нажмите кнопку "OK".



- 10 Внимательно проверьте правильность введенной информации и нажмите кнопку "Certify" (Сертифицировать).

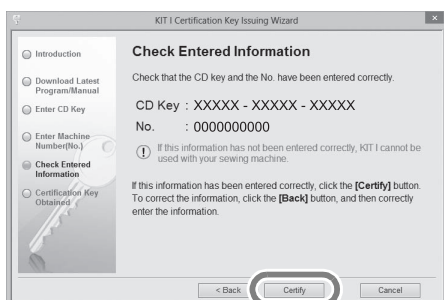

Напоминание

- Чтобы изменить введенную информацию, нажмите кнопку "Back" (Назад).

Если появится сообщение об ошибке

По приведенному ниже списку проверьте, что при вводе не сделано ошибок. Чтобы закрыть сообщение, нажмите кнопку "OK".

- Проверьте, что ключ компакт-диска и внутренний идентификационный номер машины (No.) введены правильно, а затем повторите операцию, начиная с пункта 3.
- Ключ компакт-диска действителен для использования только с одним назначенным внутренним идентификационным номером швейной машины (No.). Проверьте, что ключ компакт-диска введен правильно, и повторите операцию, начиная с пункта 3.
- Проверьте подключение к Интернету и снова нажмите кнопку "Certify".



- 11 Запишите отображаемый 8-значный ключ сертификации.



Примечание

- После обновления швейной машины путем установки Комплекта I, необходимо ввести ключ сертификации на экране настроек швейной машины.



- 12 Нажмите кнопку "Finish" (Завершить).

Ключ сертификации успешно получен.

Теперь приступайте к установке программы обновления для Комплекта I на швейную машину.

Чтобы установить программу обновления, используйте USB-устройство или компьютер.

Инструкции по установке обновления с помощью **USB-устройства** изложены ниже.

Инструкции по установке обновлений с **компьютера** изложены в пункте на с. 8.

Установка обновления с использованием

USB-устройства



- 13 Удерживая нажатой кнопку "Автоматическая заправка нити", включите швейную машину.



- 14 Скопируйте на USB-устройство программу обновления, загруженную ранее, см. пункт 6.



Примечание

- Копируйте программу обновления только на чистый форматированный USB-носитель; на этом носителе не должно быть никаких других файлов.



- 15 Нажмите 

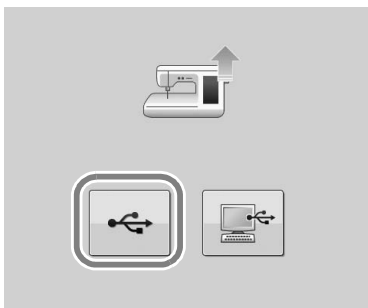

- 16 Вставьте USB-устройство в основной (верхний) USB-порт с правой стороны машины. Машине потребуется несколько секунд, чтобы распознать подключенное к порту USB-устройство.



- 17 Нажмите кнопку 



Примечание

- Когда появится сообщение "**Обновление закончено**", установка программы обновления завершена. (В случае возникновения ошибки появится сообщение красным шрифтом.)



- 18 Извлеките USB-устройство.

Выполните действия с пункта 19 на с. 9.

Установка обновления с использованием

компьютера



- 13 Удерживая нажатой кнопку "Автоматическая заправка нити", включите швейную машину.



- 14 Нажмите

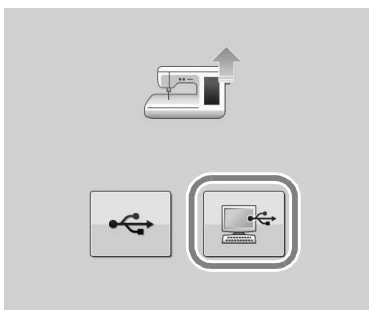

- 15 Подключите разъемы кабеля USB к соответствующим USB-портам на компьютере и на машине.

→ В папке **Компьютер (Мой компьютер)** появится значок "Съемный диск".



Примечание

- Во время использования USB-кабеля не подключайте к компьютеру никакие дополнительные USB-устройства.



- 16 Скопируйте загруженную ранее программу обновления (см. пункт 6) на **Съемный диск**.

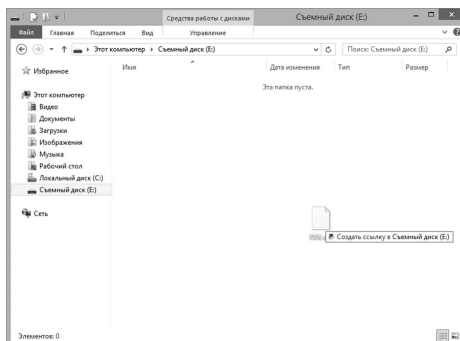

Примечание

- На ЖК-дисплее швейной машины появится сообщение "**Подсоединено к PC. Не отсоединяйте USB-кабель**".



- 17 Нажмите **ЗАГРУЗКА**.

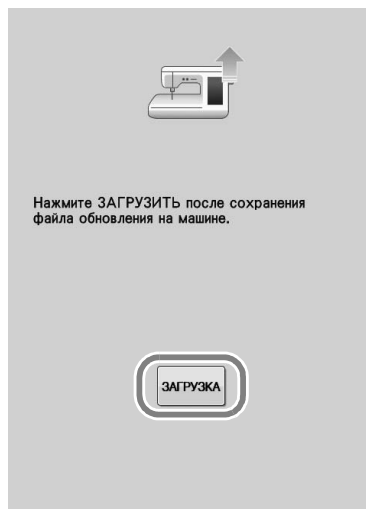

Примечание

- Когда появится сообщение "**Обновление закончено**", установка программы обновления завершена. (В случае возникновения ошибки появится сообщение красным шрифтом.)



18 Отсоедините USB-кабель.



19 Выключите и снова включите швейную машину.

20 Откройте страницу 4 или 7 экрана настроек.



21 Нажмите кнопку **СЕРТИФИКАЦИЯ** на экране настройки.

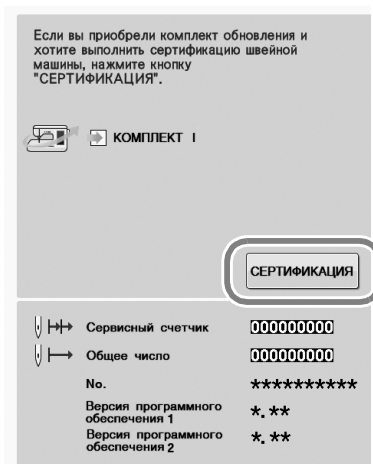

22 Нажмите кнопку **КОМПЛЕКТ 1** на следующем экране.

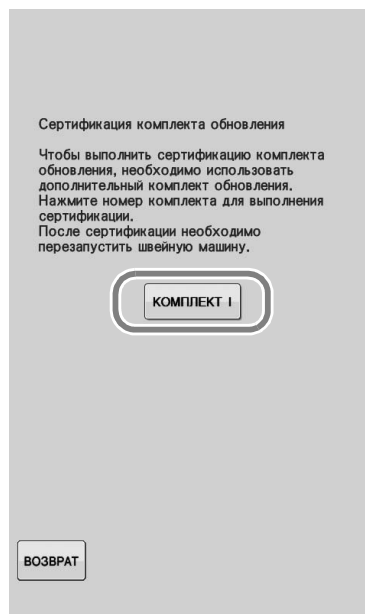

23 Введите 8-значный ключ сертификации, записанный ранее при выполнении пункта 11, и нажмите **УСТАНОВИТЬ**.





- 24** Когда появляется следующий экран, это значит, что сертификация завершена. Выключите и снова включите швейную машину.

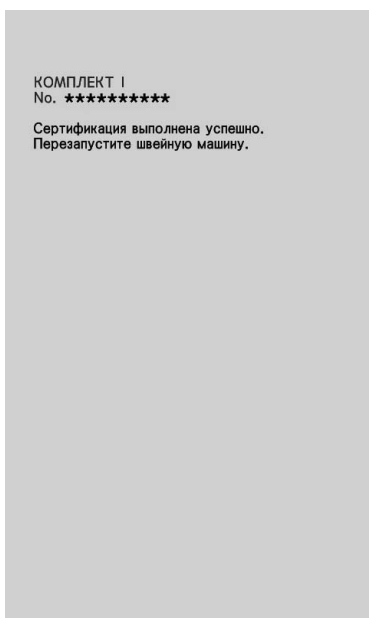

- 25** Убедитесь, что на экране настроек рядом с пунктом "Комплект I" установлен флажок.

- Сертификация "Комплекта I" успешно произведена.

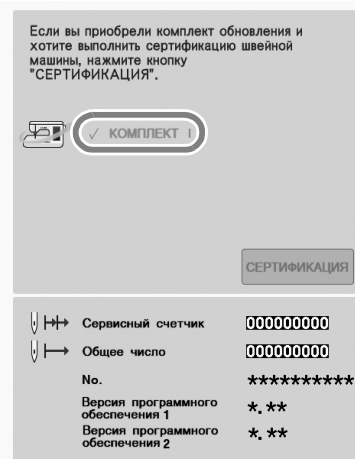

Примечание

- Если появится следующий экран, введите 8-значный ключ сертификации, записанный ранее при выполнении пункта 11, и нажмите

УСТАНОВИТЬ

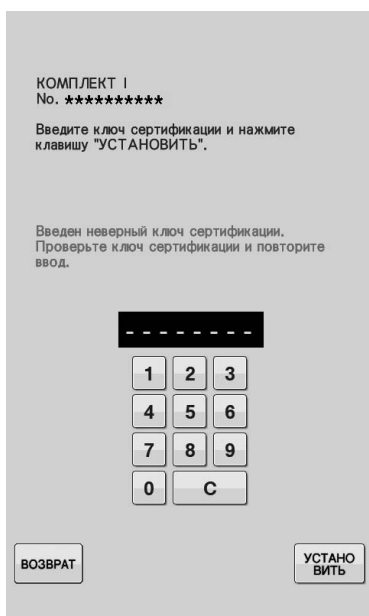

- Если ключ сертификации утерян, повторите пункты с 2 по 12, чтобы снова получить ключ сертификации.



Примечание

- Подробное описание обновленных функций см. в Руководстве пользователя. Руководство в формате PDF можно загрузить при помощи Мастера создания ключей сертификации. Инструкции по загрузке Руководства пользователя см. на с. 5.

English
German
French
Dutch
Italian
Spanish
Portuguese-BR
Russian
Printed in Taiwan



XG3164-001